



User manual

UM EN SAFETY RELAY APPLICATION

Application manual for PSR safety relays

User manual

Application manual for PSR safety relays

2012-06-20

Designation: UM EN SAFETY RELAY APPLICATION

Revision: 02

Order No.: 2888712

This user manual is valid for:
All PSR safety relays from Phoenix Contact

Please observe the following notes

User group of this manual

The use of products described in this manual is oriented exclusively to:

- Qualified electricians or persons instructed by them, who are familiar with applicable standards and other regulations regarding electrical engineering and, in particular, the relevant safety concepts.
- Qualified application programmers and software engineers, who are familiar with the safety concepts of automation technology and applicable standards.

Explanation of symbols used and signal words



This is the safety alert symbol. It is used to alert you to potential personal injury hazards. Obey all safety measures that follow this symbol to avoid possible injury or death.

There are three different categories of personal injury that are indicated with a signal word.

DANGER This indicates a hazardous situation which, if not avoided, will result in death or serious injury.

WARNING This indicates a hazardous situation which, if not avoided, could result in death or serious injury.

CAUTION This indicates a hazardous situation which, if not avoided, could result in minor or moderate injury.



This symbol together with the signal word **NOTE** and the accompanying text alert the reader to a situation which may cause damage or malfunction to the device, hardware/software, or surrounding property.



This symbol and the accompanying text provide the reader with additional information or refer to detailed sources of information.

How to contact us

Internet

Up-to-date information on Phoenix Contact products and our Terms and Conditions can be found on the Internet at:

www.phoenixcontact.com

Make sure you always use the latest documentation.

It can be downloaded at:

www.phoenixcontact.net/catalog

Subsidiaries

If there are any problems that cannot be solved using the documentation, please contact your Phoenix Contact subsidiary.

Subsidiary contact information is available at www.phoenixcontact.com.

Published by

PHOENIX CONTACT GmbH & Co. KG
Flachsmarktstraße 8
32825 Blomberg
GERMANY

Should you have any suggestions or recommendations for improvement of the contents and layout of our manuals, please send your comments to:

tecdoc@phoenixcontact.com

Please observe the following notes

General terms and conditions of use for technical documentation

Phoenix Contact reserves the right to alter, correct, and/or improve the technical documentation and the products described in the technical documentation at its own discretion and without giving prior notice, insofar as this is reasonable for the user. The same applies to any technical changes that serve the purpose of technical progress.

The receipt of technical documentation (in particular user documentation) does not constitute any further duty on the part of Phoenix Contact to furnish information on modifications to products and/or technical documentation. You are responsible to verify the suitability and intended use of the products in your specific application, in particular with regard to observing the applicable standards and regulations. All information made available in the technical data is supplied without any accompanying guarantee, whether expressly mentioned, implied or tacitly assumed.

In general, the provisions of the current standard Terms and Conditions of Phoenix Contact apply exclusively, in particular as concerns any warranty liability.

This manual, including all illustrations contained herein, is copyright protected. Any changes to the contents or the publication of extracts of this document is prohibited.

Phoenix Contact reserves the right to register its own intellectual property rights for the product identifications of Phoenix Contact products that are used here. Registration of such intellectual property rights by third parties is prohibited.

Other product identifications may be afforded legal protection, even where they may not be indicated as such.

Table of contents

1	Introduction.....	1-1
1.1	Target group for this application manual.....	1-1
1.2	What's new in this version	1-1
1.3	Symbols used.....	1-2
2	Safety of machines and systems	2-1
2.1	Functional safety	2-2
2.2	Practical procedure according to EN ISO 13849	2-2
2.2.1	Definition of the safety function	2-2
2.2.2	Determination of the required performance level (PL _r)	2-3
2.2.3	Technical implementation	2-3
2.2.4	Dividing the safety function into subsystems	2-4
2.2.5	Determination of the achieved PL for each subsystem	2-4
2.2.6	Determination of the achieved PL for the overall safety function	2-6
2.2.7	Verification of the achieved PL	2-6
2.2.8	Validation	2-6
2.3	Practical procedure according to EN ISO 62061	2-7
2.3.1	Specification of requirements for the safety-related control function (SRCF)	2-7
2.3.2	Determination of the required safety integrity level (SIL)	2-7
2.3.3	Drafting the safety-related electrical control system (SRECS)	2-7
2.3.4	Dividing the safety function into subsystems	2-8
2.3.5	Determination of the safety integrity for each subsystem	2-8
2.3.6	Determination of the achieved safety integrity for the entire SRECS	2-10
2.3.7	Verification of the achieved SIL	2-10
2.3.8	Validation	2-11
3	Safety technology basics.....	3-1
3.1	Cross-circuit detection.....	3-1
3.2	Maximum cable lengths.....	3-2
3.3	Stop.....	3-4
3.4	Safe isolation.....	3-6
4	Overview of safe switching devices	4-1
4.1	PSR safety relays	4-1
4.2	Modular safety relay system with PSR-TBUS connection.....	4-3

5	Application examples for PSR safety relays.....	5-1
5.1	Emergency stop	5-1
5.1.1	PSR-ESM4/2x1/1x2 up to PL c/SIL 1	5-2
5.1.2	PSR-ESL4/3x1/1x2/B up to PL c/SIL 1	5-4
5.1.3	PSR-ESD/4x1/30 up to PL c/SIL 1	5-6
5.1.4	PSR-ESAM4/2x1/1x2 up to PL e/SIL 3	5-8
5.1.5	PSR-ESM4/3x1/1x2/B up to PL e/SIL 3	5-10
5.1.6	PSR-ESL4/3x1/1x2/B up to PL d/SIL 2	5-12
5.1.7	PSR-ESAM4/8x1/1x2 up to PL e/SIL 3	5-14
5.1.8	PSR-ESD/4x1/30 up to PL e/SIL 3	5-16
5.1.9	PSR-ESAM4/3x1/1x2/B up to PL e/SIL 3	5-18
5.2	Light grids (ESPE)/laser scanners (AOPD).....	5-21
5.2.1	PSR-ESL4/3x1/1x2/B up to PL e/SIL 3	5-22
5.2.2	PSR-ESD/4x1/30 up to PL e/SIL 3	5-24
5.2.3	PSR-ESAM4/8x1/1x2 up to PL e/SIL 3	5-26
5.2.4	PSR-ESD/4x1/30 up to PL d/SIL 2	5-28
5.3	Movable guards.....	5-31
5.3.1	PSR-ESA4/2x1/1x2 up to PL e/SIL 3	5-32
5.3.2	PSR-ESAM4/2x1/1x2 up to PL e/SIL 3	5-34
5.3.3	PSR-ESAM4/3x1/1x2 up to PL e/SIL 3	5-36
5.3.4	PSR-ESAM4/3x1/1x2/B up to PL d/SIL 2	5-38
5.3.5	PSR-ESD/4x1/30 up to PL d/SIL 2	5-40
5.3.6	PSR-ESD/4x1/30 up to PL e/SIL 3	5-42
5.3.7	PSR-ESD/5x1/1x2/300 up to PL e/SIL 3	5-44
5.3.8	PSR-ESL4/3x1/1x2/B up to PL d/SIL 2	5-46
5.4	Enable switch	5-49
5.4.1	PSR-ESAM4/2x1/1x2 up to PL e/SIL 3	5-50
5.4.2	PSR-ESAM4/3x1/1x2/B up to PL e/SIL 3	5-52
5.4.3	PSR-ESAM4/2x1/1x2 up to PL e/SIL 3	5-54
5.5	Two-hand control device	5-57
5.5.1	PSR-THC4/2x1/1x2 up to PL e/SIL 3	5-58
5.6	Contact extension/forcibly guided contacts	5-61
5.6.1	PSR-URM4/5x1/2x2 up to PL e/SIL 3	5-62
6	Application examples for modular safety relay system with PSR-TBUS connection	6-1
6.1	PSR-SDC4/2x1/B master module.....	6-1
6.2	PSR-SDC4/2x1/B up to PL e/SIL 3.....	6-2
6.3	PSR-SDC4/2x1/B up to PL e/SIL 3.....	6-4
6.4	PSR-SDC4/2x1/B up to PL e/SIL 3.....	6-6
6.5	Contact extension/forcibly guided contacts	6-9
6.5.1	PSR-URM4/4x1/2x2/B up to PL e/SIL 3	6-10
6.5.2	PSR-URD3/4x1/2x2/3 up to PL d/SIL 2	6-12

7 Diagnostic description 7-1

A Appendix for document lists..... A-1

 A 1 List of figures A-1

 A 2 List of tables A-5

 A 4 Index..... A-3

1 Introduction

The term “safety” derives from Latin and refers to a state that is free from unacceptable risks. This fundamental human requirement is also enshrined in basic EU law.

The safety of machines and systems mainly depends on the correct application of standards and directives. In Europe, the basis for this is the Machinery Directive, which provides standard specifications to support companies when designing safety-related machines. The aim is to eliminate barriers to trade within the EU. However, even outside the European Economic Area, many European standards are gaining in importance due to their international status.

The fact that the safety of machines and systems not only depends on the components and technologies used, but is mainly affected by the “human” factor is no surprise.

However, the most important aspect is the way in which this fact is dealt with. The main focus should not only be the safety products - with their benefits and their functions - but also easy handling and associated services. The user expects considerably more support in these areas. With the slogan “simplicity means safety”, Phoenix Contact has integrated easy planning, installation, and operation of safety machines or systems and support over their entire lifecycle into its safety concept. Safety does not have to be complicated or involve a great deal of additional effort. Benefit from our expertise and experience as manufacturers of safety-related components by using products with complete application examples and access our qualified service package in all phases of the safety lifecycle.

Should you have any questions, please contact the Safety service team:

+ 49 5281 9-462777

safety-service@phoenixcontact.com

1.1 Target group for this application manual

This manual is aimed at all designers of safety controllers. This manual should provide a simple introduction to the technology of safety-related machines and systems and an overview of safety technology basics. You must always ensure you are familiar with the directives, standards, and regulations relevant to the field of application.

1.2 What's new in this version

- New standards for functional safety
- New application examples
- New diagnostics concept

1.3 Symbols used

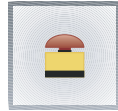

Emergency stop

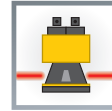

AOPDDR laser scanner

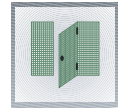

Movable guard

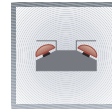

Two-hand control device

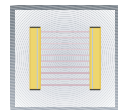

AOPD light grid



Enable switch

2 Safety of machines and systems

In modern industrial production, the amount of complex technical equipment used is constantly increasing. The purpose of safety technology is to reduce the risk to people, working animals, the environment, and machines as far as possible, and to at least a reasonable degree. The availability of production equipment should not be restricted any more than is absolutely necessary.

Safety is relative. There is no such thing as an absolutely safe machine. However, since the opening of the European single market, manufacturers and operators of machines and technical equipment are legally bound to observe European directives for the design and operation of machines and systems.

When adhering to harmonized standards (assumed effect), which apply to a machine or piece of technical equipment, it is assumed that they comply with legal regulations when launched.

The Machinery Directive is one of the most important single market directives. It is of such importance because machine construction is one of the industrial mainstays of the European Economic Area. The Machinery Directive defines the requirements machinery must meet before it can be placed on the market and operated in the European Economic Area. It also contains essential health and safety requirements for the planning and construction of machinery and safety components.

Every machine or system poses a risk. According to the requirements of the Machinery Directive, a risk assessment must be carried out for every machine.

If the risk is greater than the level of risk that can be tolerated, risk reduction must be implemented.

Standard EN ISO 12100 "Safety of machinery - General principles for design - Risk assessment and risk reduction" describes the risks to be considered and the general principles for design to reduce risk, and describes risk assessment and risk reduction as a repetitive process to achieve safety. All phases in the life of the machine are therefore assessed.

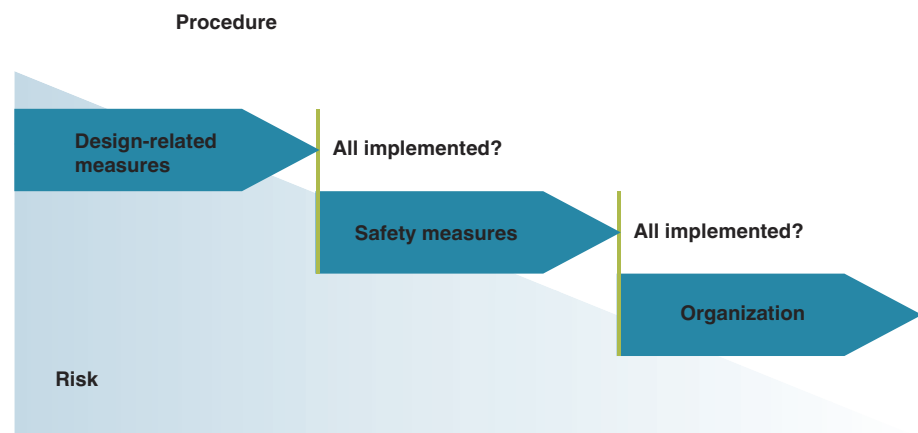

Figure 2-1 Risk reduction in machines

2.1 Functional safety

Safety-related parts of machine control systems are frequently assigned to provide safety functions. The contribution to the overall risk reduction of machinery by the safety-related parts of a control system is determined according to EN ISO 12100.

In order to achieve the necessary functional safety of a machine or system, it is essential for the safety-related parts of the safety equipment and control devices to operate correctly and, in the event of failure, for the system to remain in the safe state or enter a safe state.

The requirements for achieving functional safety are based on the following objectives:

- Avoidance of systematic errors
- Control of systematic errors
- Control of random faults or failures

The requirements of the safety-related parts of a machine control system are specified in EN ISO 13849 (and EN 62061). The standard specifies the various safety levels in the form of the "performance level" (and "safety integrity level" (SIL)) for the safety-related parts according to the degree of risk and describes the characteristics of the safety functions.

2.2 Practical procedure according to EN ISO 13849

In practice, the following steps have proven effective when designing safe controllers according to EN ISO 13849.

2.2.1 Definition of the safety function

The safety functions must be defined first. This information is derived from the risk assessment.

Example:

Trigger event:	Opening the safety door.
Response:	The robot drive is set to a safe stop state. The power semiconductor pulses are disabled.
Safe state:	Power circuit has no power.

2.2.2 Determination of the required performance level (PL_r)

The PL_r is determined in combination with the safety function within the framework of the higher-level risk assessment. For each safety function, the required PL_r is estimated using the risk graph below.

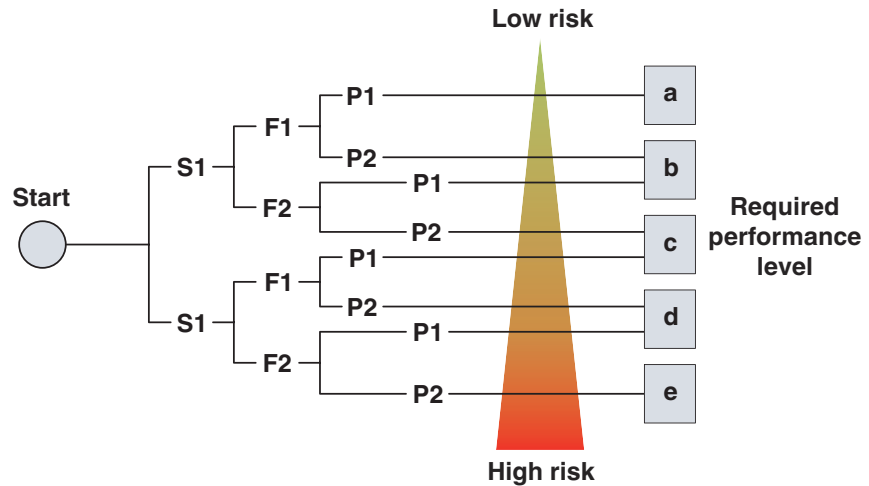

Figure 2-2 Risk graph (according to EN 13849-1)

Meaning of individual parameters:

S: severity of injury

S1 Slight (normally reversible) injury

S2 Serious (normally irreversible) injury

F: frequency and duration of exposure to the hazard

F1 Seldom to not very frequent or exposure to hazard is brief

F2 Frequent to continuous or exposure to hazard is long

P: possibility of avoiding or limiting damage

P1 Possible under specific conditions

P2 Scarcely possible

2.2.3 Technical implementation

This step involves the technical pre-planning of the safety function, taking possible technologies and components into account. The safety-related components and parts must then be identified for later verification.

2.2.4 Dividing the safety function into subsystems

In the next step, a safety-related block diagram must be created for further evaluation. As a rule, a safety function consists of sensor - logic - actuator. In the simplest case, each one is a subsystem. These subsystems are connected in series to form the overall safety function.



Figure 2-3 Safety-related block diagram (according to EN 13849-1)

2.2.5 Determination of the achieved PL for each subsystem

A characteristic value when determining the performance level is the PFH_d value, the statistical “probability of a dangerous failure per hour”. The safety characteristics can be found in the FUNCTIONAL SAFETY CHARACTERISTICS data sheet or the SISTEMA library.

The diagram below shows the basic relationship between PL and the safety characteristics category, DC, and MTTF_d.

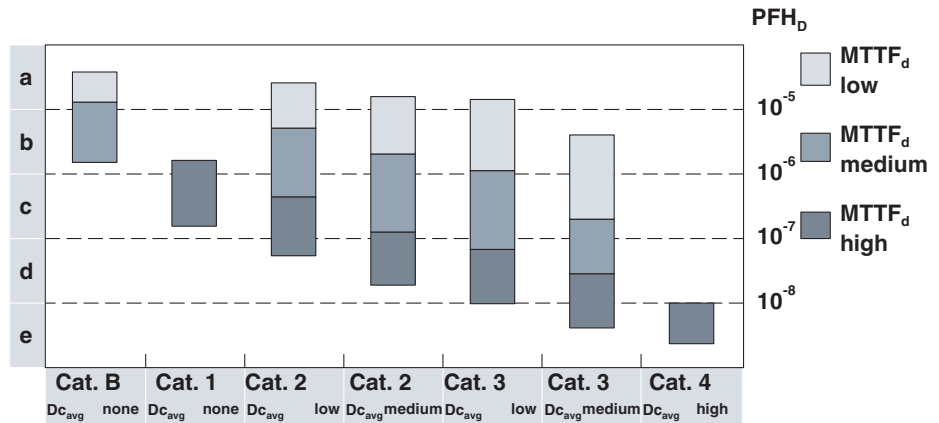

Figure 2-4 Relationship between PL, category, DC, and MTTFd (according to EN 13849-1)

The category is an important parameter when determining the PL. The category term has been taken from the previous standard EN 954-1. The requirements for the categories are listed below.

Table 2-1 Explanation of categories

Category	Summary of requirements	System behavior	Principle to achieve safety
B	Safety-related parts of control systems and/or their protective equipment, as well as their components, shall be designed, constructed, selected, assembled, and combined in accordance with relevant standards so that they can withstand the expected influences. Basic safety principles must be used.	The occurrence of a fault can lead to the loss of the safety function.	Mainly characterized by the selection of components.
1	The requirements of category B must be met. Proven components and proven safety principles must be used.	The occurrence of a fault can lead to the loss of the safety function but the probability of occurrence is lower than that for category B.	Mainly characterized by the selection of components.
2	The requirements of category B and the use of proven safety principles must be met. The safety function must be tested by the machine control system at suitable intervals.	The occurrence of a fault can lead to the loss of the safety function between the tests. The loss of the safety function is detected by the test.	Mainly characterized by the structure.
3	The requirements of category B and the use of proven safety principles must be met. Safety-related parts must be designed so that: <ul style="list-style-type: none"> – A single fault in any of these parts does not lead to the loss of the safety function; and – the single fault is detected, whenever this is feasibly possible. 	When the single fault occurs, the safety function is always performed. Some but not all faults are detected. An accumulation of undetected faults can lead to the loss of the safety function.	Mainly characterized by the structure.
4	The requirements of category B and the use of proven safety principles must be met. Safety-related parts must be designed so that: <ul style="list-style-type: none"> – A single fault in any of these parts does not lead to the loss of the safety function; and – the single fault is detected on or before the next demand of the safety function. If detection is not possible, an accumulation of undetected faults must not lead to the loss of the safety function. 	When the single fault occurs, the safety function is always performed. The detection of accumulated faults reduces the probability of the loss of the safety function (high DC). The faults are detected in time to prevent a loss of the safety function.	Mainly characterized by the structure.

2.2.6 Determination of the achieved PL for the overall safety function

For subsystems with integrated diagnostic functions such as safety devices and safety controllers, the achieved PFH_d and PL are provided by the manufacturer with the specification of the category.

For subsystems consisting of discrete components (e.g., switches, contactors, valves, etc.), the PFH_d value is determined from the category, DC, and $MTTF_d$. For components that are subject to wear, the $MTTF_d$ is determined based on the number of operating cycles using the B10d value provided by the component manufacturer.

In addition, for category 2 or higher the effect of common cause failure (CCF) must also be considered.

2.2.7 Verification of the achieved PL

Each individual subsystem and the entire safety chain must both meet the requirements of the necessary PL_r . This includes both the quantitative evaluation and the consideration of systematic aspects, such as proven components and safety principles.

The systematic aspects include:

- Correct dimensioning of components
- Consideration of expected operating conditions and ambient conditions
- Use of basic and proven safety principles
- Avoidance of specification errors and software errors through testing

2.2.8 Validation

The last step should check whether the selected measures achieve the necessary risk reduction and therefore the protection objectives of the risk assessment. The result of the validation process is included in the final risk assessment.

The purpose of the validation process is to confirm the specification and level of conformity of the design of safety-related parts of the control system (SRP/CS) within the overall specifications for the safety requirements of the machinery. Before validation of the design of the SRP/CS or the combination of SRP/CS that contains the safety function, the specification requirement for the safety function must be confirmed. Validation involves performing analysis and function tests under normal conditions in accordance with the validation plan.

EN ISO 13849-2 contains detailed requirements and describes the basic procedure for the individual validation processes.

2.3 Practical procedure according to EN ISO 62061

In practice, the following steps have proven effective when designing safe controllers according to EN 62061.

2.3.1 Specification of requirements for the safety-related control function (SRCF)

The safety function must be defined first. This information is derived from the risk assessment.

Example:

Trigger event: Opening the safety door.
 Response: The robot drive is set to a safe stop state. The power semiconductor pulses are disabled.
 Safe state: Power circuit has no power.

2.3.2 Determination of the required safety integrity level (SIL)

The required SIL is determined in combination with the safety function within the framework of the higher-level risk assessment.

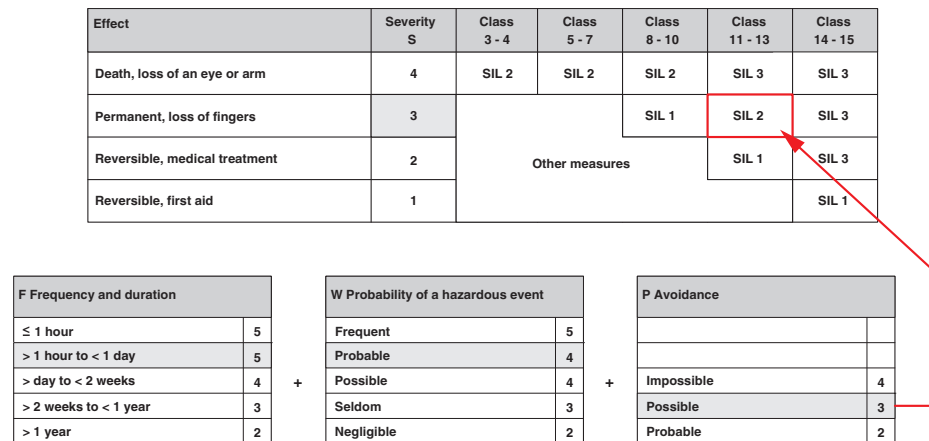

Figure 2-5 Example of specifying the SIL (according to EN 62061)

2.3.3 Drafting the safety-related electrical control system (SRECS)

This step involves the technical pre-planning of the safety function, taking possible technologies and components into account. The safety-related components and parts must then be identified for later verification.

2.3.4 Dividing the safety function into subsystems

Following technical implementation and identification of safety-related components, a safety-related block diagram must be created for further evaluation. As a rule, a safety function consists of sensor - logic - actuator (see “Safety-related block diagram (according to EN 13849-1)” on page 2-4). In the simplest case, each one is a subsystem. These subsystems are connected in series to form the overall safety function.

2.3.5 Determination of the safety integrity for each subsystem

A characteristic value when determining the safety integrity level (SIL) is the PFH_d value, the statistical “probability of a dangerous failure per hour”.

The safety characteristics for Phoenix Contact products can be found in the FUNCTIONAL SAFETY CHARACTERISTICS data sheet. Standard EN 62061 describes the subsystem architectures type A to D, which are similar to the categories of EN ISO 13849-1.

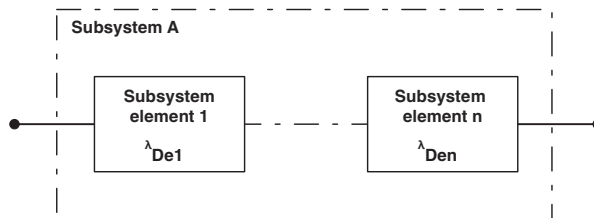

Figure 2-6 Logical representation of subsystem A (according to EN 62061)

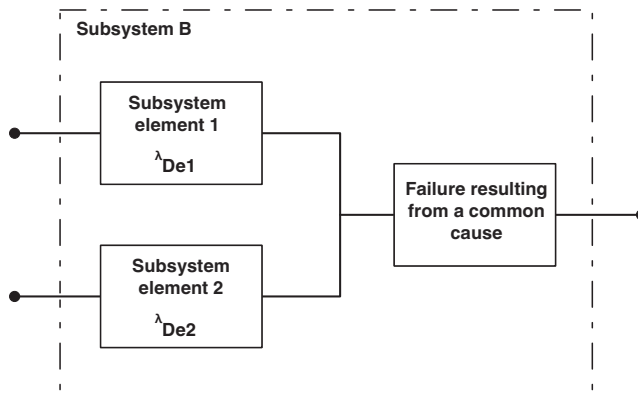

Figure 2-7 Logical representation of subsystem B (according to EN 62061)

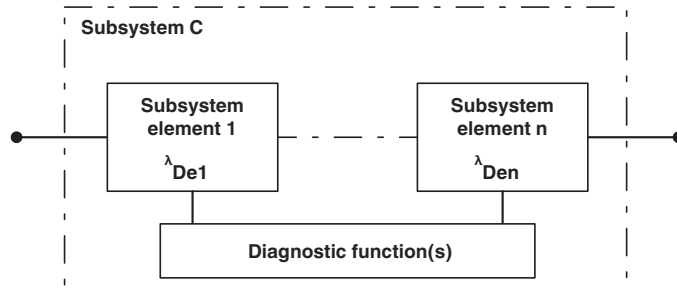

Figure 2-8 Logical representation of subsystem C (according to EN 62061)

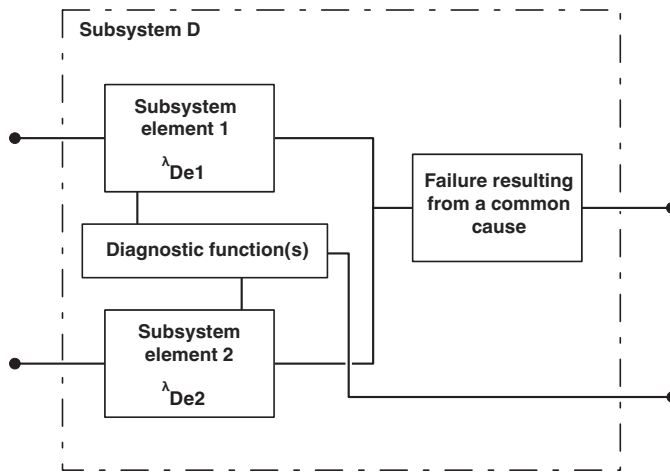

Figure 2-9 Logical representation of subsystem D (according to EN 62061)

For subsystems with integrated diagnostic functions such as safety devices and safety controllers, the achieved PFH_d and SIL CL are provided by the manufacturer.

For subsystems consisting of discrete components (e.g., switches, contactors, etc.), the PFH_d value is calculated according to the subsystem type using a specific formula (see Section 6.7.8.2 of EN 62061). For components that are subject to wear, the failure rate is determined based on the number of operating cycles using the $B10_d$ value provided by the component manufacturer.

2.3.6 Determination of the achieved safety integrity for the entire SRECS

To determine the achieved safety integrity level, the PFH_d values of the individual subsystems must now be added together. The result must lie within the SIL required for the safety function.

Table 2-2 Determination of the safety integrity level (according to EN 62061)

Safety integrity level	Probability of a dangerous failure per hour (PFH_D)
3	$\geq 10^{-8}$ to $< 10^{-7}$
2	$\geq 10^{-7}$ to $< 10^{-6}$
1	$\geq 10^{-6}$ to $< 10^{-5}$

Furthermore, the SIL CL of an individual subsystem determines the maximum achievable SIL for the SRECS. For safety components with integrated diagnostics, this is provided by the manufacturer. For subsystems consisting of discrete components, this value must be determined using the table below.

Table 2-3 Determination of the safety integrity level for a subsystem with discrete components (according to EN 62061)

Safe failure fraction	Hardware fault tolerance ¹⁾		
	0	1	2
< 60%	Not permitted ²⁾	SIL 1	SIL 2
60% to < 90%	SIL 1	SIL 2	SIL 3
90% to < 99%	SIL 2	SIL 3	SIL 3
$\geq 99\%$	SIL 3	SIL 3	SIL 3

¹⁾ A hardware fault tolerance of N means that N + 1 faults can lead to a loss of the SRCF.

²⁾ See EN ISO 62061, Section 6.7.7

2.3.7 Verification of the achieved SIL

Each individual subsystem and the entire safety chain must both meet the requirements of the necessary SIL. This includes both the quantitative evaluation and the consideration of systematic aspects.

The systematic aspects include:

- Correct dimensioning of components
- Consideration of expected operating conditions and ambient conditions
- Use of basic and proven safety principles
- Avoidance of specification errors and software errors through testing

2.3.8 Validation

The last step should check whether the selected measures achieve the necessary risk reduction and therefore the protection objectives.

The result of the validation process is included in the final risk assessment.

The purpose of the validation process is to confirm the specification and level of conformity of the design of safety-related parts of the control system (SRP/CS) within the overall specifications for the safety requirements of the machinery. Before validation of the design of the SRP/CS or the combination of SRP/CS that contains the safety function, the specification requirement for the safety function must be confirmed. Validation involves performing analysis and function tests under normal conditions in accordance with the validation plan.

EN ISO 13849-2 contains detailed requirements and describes the basic procedure for the individual validation processes.

3 Safety technology basics

3.1 Cross-circuit detection

In both category 3 and category 4, a first fault must never lead to the loss of the safety function. This often makes it necessary to provide redundancy in the control structure.

Cross-circuit detection has the ability to detect short circuits, bridges or short circuits to ground between two channels either immediately or within the framework of cyclic self-monitoring.

A cross circuit may be due to one of the following reasons:

- Squeezing
- High temperatures
- Chips
- Acids

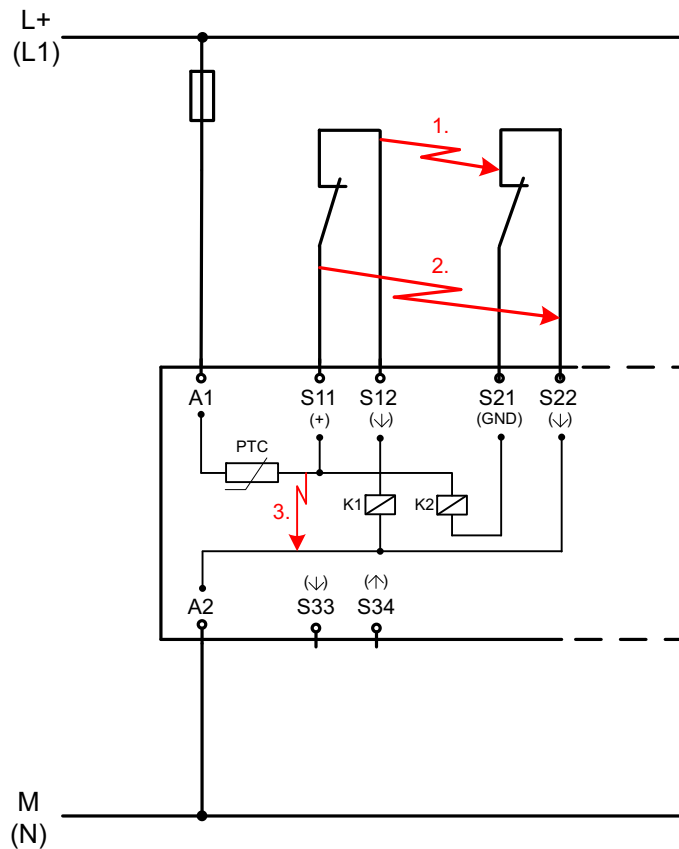

Figure 3-1 Cross-circuit detection

3.2 Maximum cable lengths

Depending on the size of the machine or system, a considerable amount of cabling may be required to wire the sensors.



Make sure that the specified cable lengths are not exceeded, so as to ensure error-free operation of the safety relay.

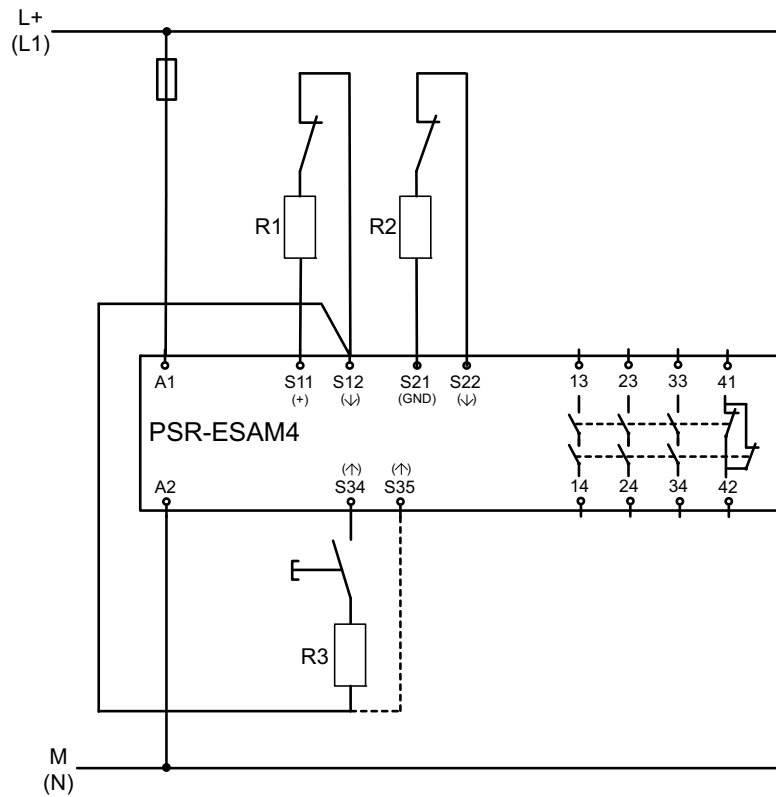

Figure 3-2 Cable lengths

Example: For an emergency stop application with the PSR-ESAM4 (see Figure 3-2), the following calculations can be made:

Assumed values: Cable cross section: $A = 1.5 \text{ mm}^2$
 Electrical conductivity of copper (Cu): $\kappa = 56 \text{ m}/(\Omega \times \text{mm}^2)$ (at 20°C)

Technical data for the safety relay: Input data:
 Maximum voltage drop for S11-S12, S21-S22, and S33-S34: approximately 2 V DC (corresponds to approximately $50 \Omega = R_L$)



The specified values can be found in the data sheet for the corresponding safety relay.

$$R_L = R1 + R2 + R3$$

$$R_L = 50 \Omega$$

Calculated value: $l = R_L \times A \times \kappa$
 $l = 50 \Omega \times 1.5 \text{ mm}^2 \times 56 \text{ m}/\Omega \times \text{mm}^2$
 $l = 4200 \text{ m}$

Where:

- l Permissible cable length
- R_L Cable resistance
- A Cable cross section
- κ (Kappa) Electrical conductivity of copper (Cu)

This refers to the forward and return line for both channels in the enable circuit and reset circuit (S11-S12, S21-S22, and S12-S34).



If the application is operated with an automatic start, the cable lengths between S12-S35 can be disregarded.

3.3 Stop

Stop categories according to EN 60204-1

Every machine must be fitted with emergency stop equipment.

As per EN 60204-1, this must be implemented in stop category 0 or stop category 1 and must be able to function independently of the operating mode.

In order to stop a machine, three stop categories are defined in EN 60204-1, which describe the stop control sequence independently of an emergency situation.

Stop category 0

- Stopping by immediate removal of power to the machine drives (i.e., an uncontrolled stop).

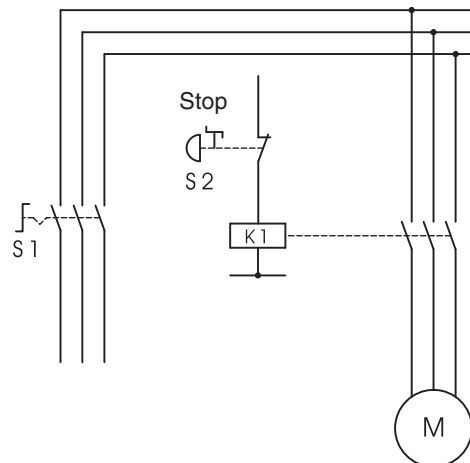

Figure 3-3 Stop category 0 example

Stop category 1

- A controlled stop with power available to the machine drives to achieve the stop; power is removed only when the stop is achieved.

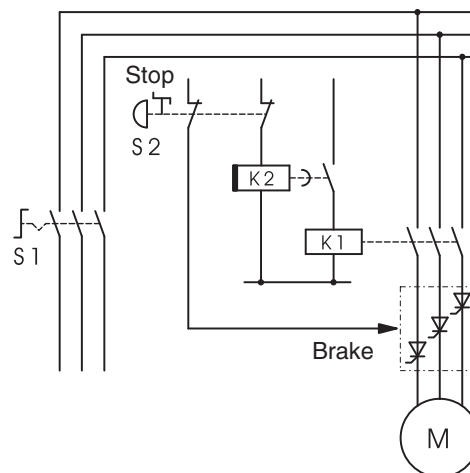

Figure 3-4 Stop category 1 example

Stop category 2

- A controlled stop with power available to the machine drives.

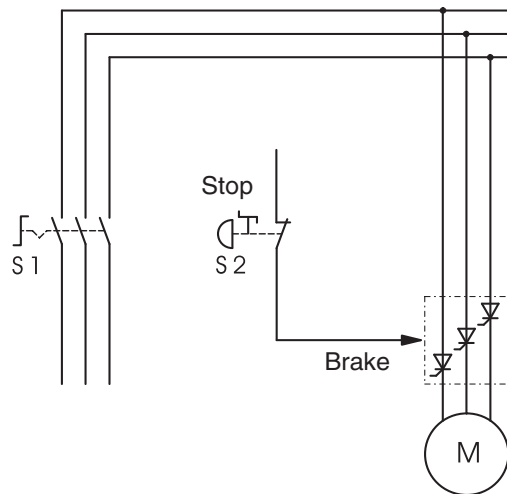

Figure 3-5 Stop category 2 example

3.4 Safe isolation

Depending on the version, the PSR safety relays have safe isolation between input and output and between the contacts. Applications with 230 V low voltage can be connected reliably and safely.

Insulation between input circuit and enabling current path

PSR safety relays provide safe isolation, reinforced insulation, and 6 kV between the input circuit and the enabling current paths. In EN 50178, safe isolation is required if SELV and PELV are switched together or led directly next to one another in a device. Due to the internal structure and the insulation properties between the input and the contacts in Phoenix Contact PSR safety relays, 230 V AC, for example, can be switched without any limitations. Depending on the type, the output contacts (13-14, 23-24, etc.) are isolated from one another using basic insulation or reinforced insulation.

Basic insulation between enabling current paths

(Impulse voltage withstand level: 4 kV)

A mixture of SELV and PELV is strictly prohibited. Only switch 230 V AC at one of the enable contacts if the adjacent contact carries the same potential.

Reinforced insulation between the enabling current paths

(Impulse voltage withstand level: 6 kV)









Reinforced insulation (e.g., greater air and creepage distances between conductive paths) is designed for a higher surge voltage category than basic insulation. Therefore, SELV circuits $U \leq 25$ V AC or $U \leq 60$ V DC and circuits with higher voltages can be mixed.

4 Overview of safe switching devices

Phoenix Contact offers a comprehensive range of products for safety functions in mechanical engineering.









4.1 PSR safety relays

Table 4-1 Overview of PSR safety relays

Order No.	Type	Application					Output contacts			Safety approval			Application example, see page ...	Diagnostic description, see page ...
										Cat. EN ISO 13849-1	PL EN ISO 13849-1	SIL CL EN IEC 62061		
2963802	PSR-ESA2/4x1/1x2/B	X	X	-	-	-	4	-	1	2	d	3	-	7-2
2963954														
2963750	PSR-ESA4/2x1/1x2	X	X	-	-	-	2	-	1	4	e	3	5-32	7-3
2963938														
2963705	PSR-ESM4/2x1/1x2	X	X	-	-	-	2	-	1	4	e	3	5-2	-
2963718														
2963776	PSR-ESM4/3x1/1x2/B	X	X	-	-	-	3	-	1	4	e	3	5-10	7-1
2963925														
2901430	PSR-ESAM2/3x1/1x2/B	X	X	-	-	-	3	-	1	2	d	2	-	7-2
2901431														
2900525	PSR-ESAM4/2x1/1x2	X	X	-	-	-	2	-	1	4	e	3	5-8 5-34 5-50 5-54	7-2 7-3
2900526														
2900509	PSR-ESAM4/3x1-B 24 V AC/DC	X	X	-	-	-	3	-	1	4	e	3	5-18 5-38 5-52	7-1
2900510														
2901416	PSR-ESAM4/3x1-B 42 - 48 V AC/DC	X	X	-	-	-	3	-	1	4	e	3		
2901417														
2901426	PSR-ESAM4/3x1-B 60 V AC/DC	X	X	-	-	-	3	-	1	4	e	3		
2901427														
2901422	PSR-ESAM4/3x1-B 120 V AC/DC	X	X	-	-	-	3	-	1	4	e	3		
2901425														
2901428	PSR-ESAM4/3x1-B 230 V AC/DC	X	X	-	-	-	3	-	1	4	e	3		
2901429														
2981114	PSR-ESAM4/3x1/1x2	X	X	-	-	-	3	-	1	4	e	3	5-36	-
2981127														
2963912	PSR-ESAM4/8x1/1x2	X	X	X	-	-	8	-	1	4	e	3	5-14 5-26	7-2
2963996														

Application manual for PSR safety relays









Table 4-1 Overview of PSR safety relays

Order No.	Type	Application					Output contacts			Safety approval			Application example, see page ...	Diagnostic description, see page ...
										Cat. EN ISO 13849-1	PL EN ISO 13849-1	SIL CL EN IEC 62061		
2981059	PSR-ESL4/3x1/1x2/B	X	X	X	-	-	3	-	1	4	e	3	5-4 5-12 5-22 5-46	7-2
2981062														
2981800	PSR-ESD-30	X	X	X	-	-	2	2	0	4	e	3	5-6 5-16 5-24 5-28 5-40 5-42	7-7
2981813														
2981428	PSR-ESD/5x1/1x2/300	X	X	X	-	-	3	2 ¹⁾	1	4	e	3	5-44	7-5
2981431														
Ordering data can be found in the catalog	PSR-ESD-T	X	X	X	-	-	3	2 ¹⁾	1	4	e	3	-	-
2963721	PSR-THC4	-	X	-	-	X	2	-	1	4	e	3	5-58	7-2
2963983														
2963734	PSR-URM4/5x1/2x2	Contact extension					5	-	2	4	e	3	5-62	7-8
2964005														
2981033	PSR-URM4/5x1/2x2/B	Contact extension					5	-	2	4	e	3	-	7-9
2981046														

¹⁾ Delayed contacts only category 3

4.2 Modular safety relay system with PSR-TBUS connection

Table 4-2 Overview of PSR-SDC4 modular safety relay system

Order No.	Type	Application					Output contacts			Safety approval			Application example, see page ...	Diagnostic description, see page ...
										Cat. EN ISO 13849-1	PL EN ISO 13849-1	SIL CL EN IEC 62061		
2981486	PSR-SDC4/2x1/B	X	X	X	X	-	2	-	1 ²⁾	4	e	3	6-2 6-4 6-6	7-10
2981499														
2981677	PSR-URM4/B	Contact extension					4	-	2	4	e	3	6-10	7-11
2981680														
2981732	PSR-URD3/3	Contact extension					-	4	2 De- layed	3	d	2	6-12	7-11
2981745														
2981512	PSR-URD3/30	Contact extension					-	4	2 De- layed	3	d	2	-	-
2981525														
2981703	PSR-URD3/T2	Contact extension					-	4	2 De- layed	3	d	2	-	-
2981729														

²⁾ Non-isolated

5 Application examples for PSR safety relays

5.1 Emergency stop

**Emergency stop
(according to
EN ISO 13850,
EN 60204-1)**

An emergency operation intended to stop a process or a movement that would become hazardous (stop).

The emergency stop function is triggered by a single operator operation. This function must be available and operational at all times according to EN ISO 13850. In this case, the operating mode is not taken into consideration.

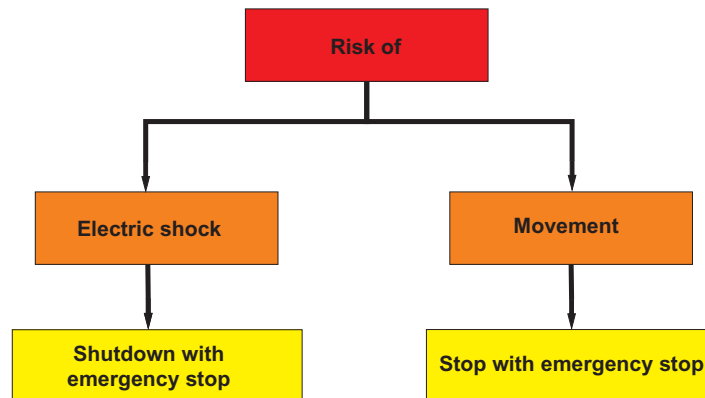
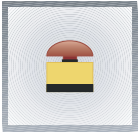

Figure 5-1 Emergency stop

The emergency stop function should not be used as a substitute for safety equipment or other safety functions, but should be designed as additional safety equipment. The emergency stop function must not adversely affect the effectiveness of safety equipment or equipment with other safety functions.

Furthermore, it must be designed so that when faced with the decision to activate the manual emergency stop control, the operator does not have to consider the resulting effects.



5.1.1 PSR-ESM4/2x1/1x2 up to PL c/SIL 1

Single-channel emergency stop monitoring with manual reset

Order No.	2963718 with screw connection 2963705 with spring-cage connection
Technical data	<ul style="list-style-type: none"> - 24 V AC/DC - 2 enabling current paths, 1 signaling current path - Monitored manual start - Reinforced insulation - Cross-circuit detection - Cat. 4/PL e according to EN ISO 13849-1, SIL CL 3 according to EN 62061

Application example

- Single-channel emergency stop monitoring
- Manual reset (S33, S34)
- Stop category 0
- Safety level of the example up to PL c (EN ISO 13849-1) and SIL 1 (EN 62061)

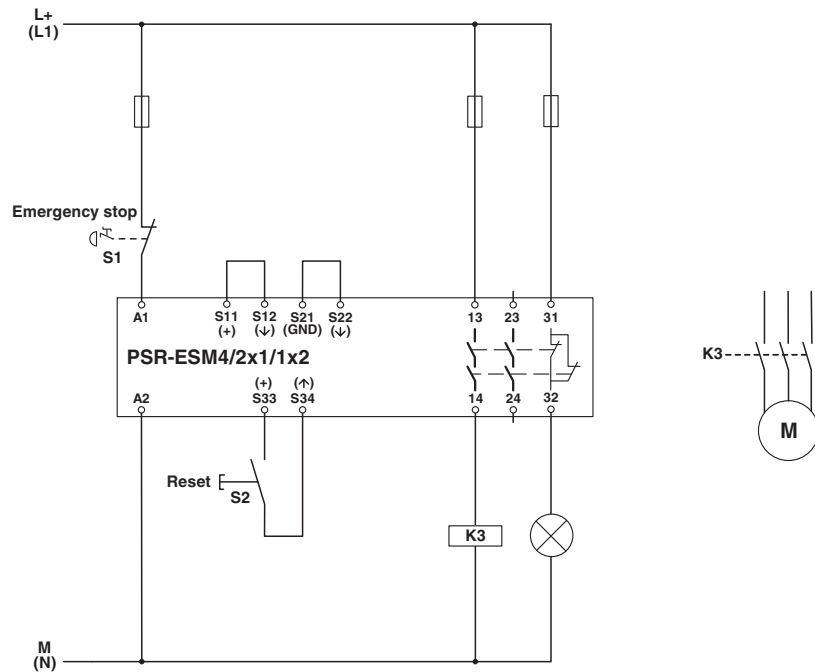

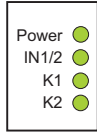
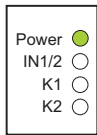

Figure 5-2 Single-channel emergency stop monitoring with manual reset PSR-ESM4/2x1/1x2

Function description

Start	Action	Result	Diagnostics
	1. Unlock emergency stop button S1.	The emergency stop circuit supplies the safety relay. The circuit is enabled via the reset button.	
	2. Press reset button S2.	Contactors K3 is activated.	
Stop	Action	Result	Diagnostics
	1. Press emergency stop button S1.	The safety function is triggered and contactor K3 is opened.	

For additional diagnostic descriptions, please refer to Section 7.

Notes on the application example

1. The emergency stop control device is positive opening according to EN 60947-5-1.
2. Stop category 0 describes an immediate stop by removal of power by interrupting a machine or drive element according to EN 60204.
3. Proven components and proven safety principles according to EN ISO 13849-2 must be used when applying category 1.
4. The occurrence of a fault can lead to the loss of the safety function.
5. The connecting cables for the emergency stop control device should either be laid separately or protected against mechanical damage.
6. When using the safety relay, take into consideration the maximum permissible number of cycles for observing the SIL/PL safety characteristics in the specific application. The safety characteristics can be found in the FUNCTIONAL SAFETY CHARACTERISTICS data sheet or the SISTEMA library.

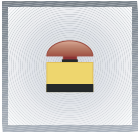

5.1.2 PSR-ESL4/3x1/1x2/B up to PL c/SIL 1

Single-channel emergency stop monitoring with manual reset

Order No.	2981059 with screw connection 2981062 with spring-cage connection
Technical data	<ul style="list-style-type: none"> - 24 V AC/DC - 3 enabling current paths, 1 signaling current path - Monitored manual or automatic start - Basic insulation - Stop category 0 - Cat. 4/PL e according to EN ISO 13849-1, SIL CL 3 according to EN 62061

Application example

- Single-channel emergency stop monitoring
- Manual reset (S33, S34)
- Stop category 0
- Safety level of the example up to PL c (EN ISO 13849-1) and SIL 1 (EN 62061)

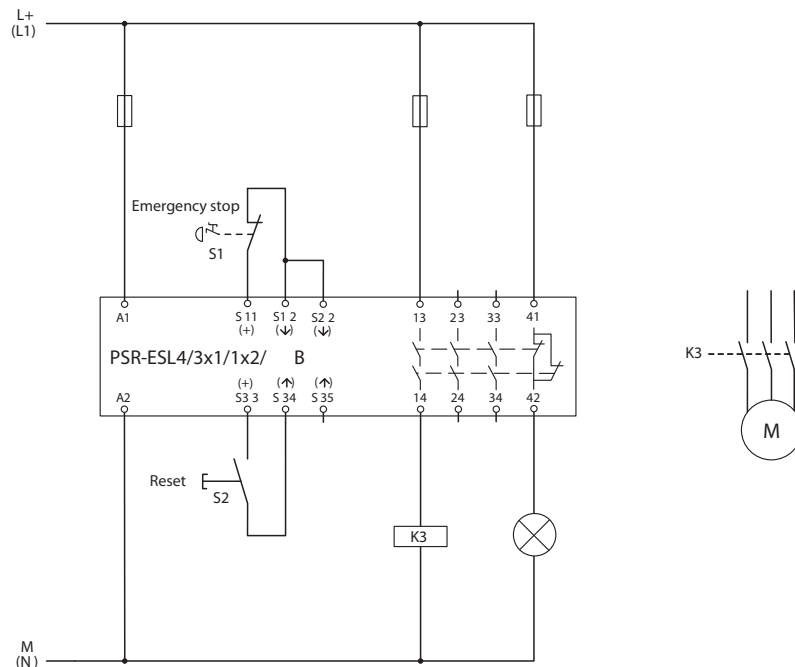
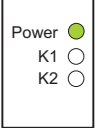
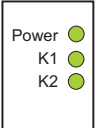
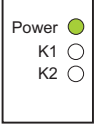

Figure 5-3 Single-channel emergency stop monitoring with manual reset PSR-ESL4/3x1/1x2/B

Function description

Start	Action	Result	Diagnostics
	1. Unlock emergency stop button S1.	The emergency stop button closes enable circuit S11 and S12 of the safety relay. The circuit is enabled via the reset button.	
	2. Press reset button S2.	Contactors K3 is activated.	
Stop	Action	Result	Diagnostics
	1. Press emergency stop button S1.	The safety function is triggered and contactor K3 is opened.	

For additional diagnostic descriptions, please refer to Section 7.

Notes on the application example

1. The emergency stop control device is positive opening according to EN 60947-5-1.
2. Stop category 0 describes an immediate stop by removal of power by interrupting a machine or drive element according to EN 60204.
3. Proven components and proven safety principles according to EN ISO 13849-2 must be used when applying category 1.
4. The occurrence of a fault can lead to the loss of the safety function.
5. The connecting cables for the emergency stop control device should either be laid separately or protected against mechanical damage.
6. When using the safety relay, take into consideration the maximum permissible number of cycles for observing the SIL/PL safety characteristics in the specific application. The safety characteristics can be found in the FUNCTIONAL SAFETY CHARACTERISTICS data sheet or the SISTEMA library.

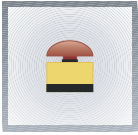

5.1.3 PSR-ESD/4x1/30 up to PL c/SIL 1

Single-channel emergency stop monitoring with manual reset

Order No.	2981800 with screw connection 2981813 with spring-cage connection
Technical data	<ul style="list-style-type: none"> - 24 V DC - 2 undelayed enabling current paths, 2 delayed enabling current paths - Adjustable delay time (0 ... 30 s) - Monitored manual or automatic start - Basic insulation - Cat. 4/PL e according to EN ISO 13849-1, SIL CL 3 according to EN 62061

Application example

- Single-channel emergency stop monitoring
- Manual reset (A1, S34)
- Stop category 0
- Safety level of the example up to PL c (EN ISO 13849-1) and SIL 1 (EN 62061)

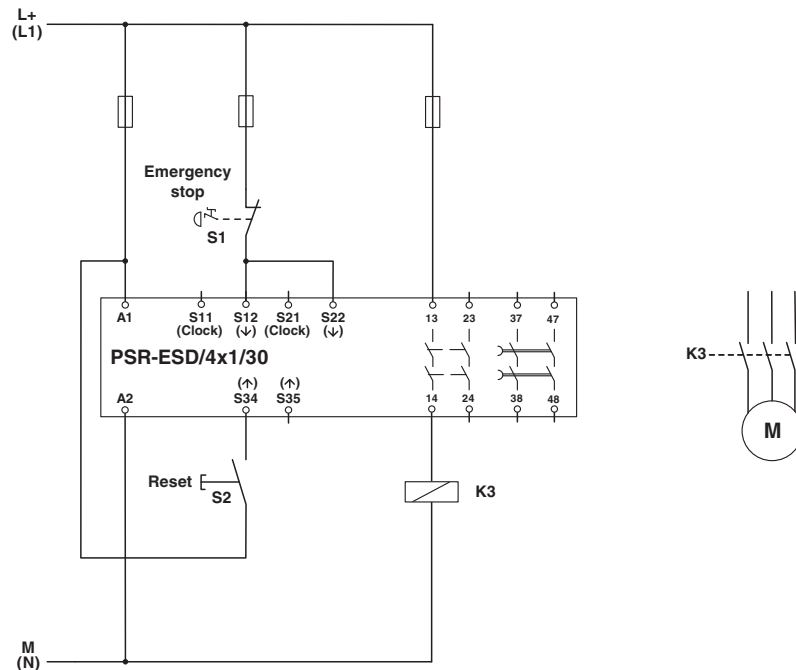

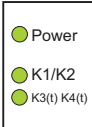
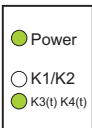
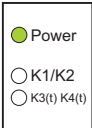

Figure 5-4 Single-channel emergency stop monitoring with manual reset PSR-ESD/4x1/30

Function description

Start	Action	Result	Diagnostics
	1. Unlock emergency stop button S1.	The emergency stop button closes enable circuit S12 and S22 of the safety relay. The circuit is enabled via the reset button.	
	2. Press reset button S2.	Contactors K3 is activated.	
Stop	3. Press emergency stop button S1.	The safety function is triggered and contactor K3 is opened immediately.	
		After the preset time has elapsed, the delayed enable contacts of the safety relay are opened.	

For additional diagnostic descriptions, please refer to Section 7.

Notes on the application example

1. The emergency stop control device is positive opening according to EN 60947-5-1.
2. Stop category 0 describes an immediate stop by removal of power by interrupting a machine or drive element according to EN 60204.
3. Proven components and proven safety principles according to EN ISO 13849-2 must be used when applying category 1.
4. The occurrence of a fault can lead to the loss of the safety function.
5. The connecting cables for the emergency stop control device should either be laid separately or protected against mechanical damage.
6. When using the safety relay, take into consideration the maximum permissible number of cycles for observing the SIL/PL safety characteristics in the specific application. The safety characteristics can be found in the FUNCTIONAL SAFETY CHARACTERISTICS data sheet or the SISTEMA library.

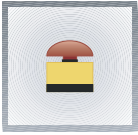

5.1.4 PSR-ESAM4/2x1/1x2 up to PL e/SIL 3

Two-channel emergency stop monitoring with manual reset
(with cross-circuit detection)

Order No.	2900525 with screw connection 29600526 with spring-cage connection
Technical data	<ul style="list-style-type: none"> - 24 V AC/DC - 2 enabling current paths, 1 signaling current path - Monitored manual or automatic start - Reinforced insulation - Cat. 4/PL e according to EN ISO 13849-1, SIL CL 3 according to EN 62061

Application example

- Two-channel emergency stop monitoring
- Cross-circuit detection
- Ground fault detection (S11, S12)
- Manual reset (S12, S34)
- Feedback of contactor contacts K3 ... K6 at S34
- Stop category 0
- Monitoring of external contactors
- Safety level of the example up to PL e (EN ISO 13849-1) and SIL 3 (EN 62061)

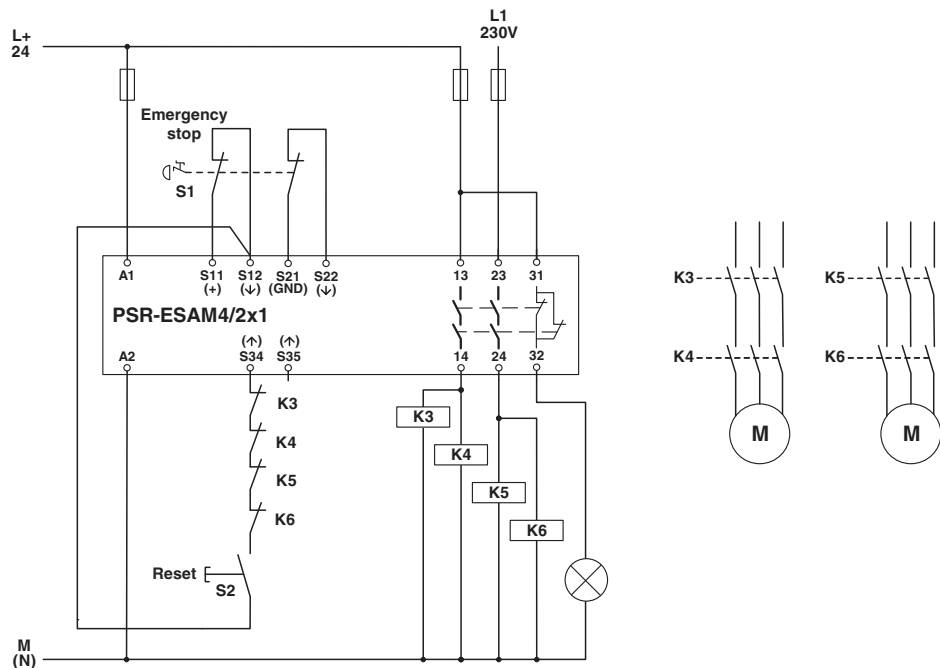

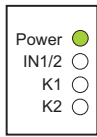

Figure 5-5 Two-channel emergency stop monitoring with manual reset
PSR-ESAM4/2x1/1x2

Function description

Start	Action	Result	Diagnostics
	1. Unlock emergency stop button S1.	The emergency stop button closes enable circuit S11, S12 and S21, S22 of the safety relay. The circuit is enabled via the reset button.	
	2. Press reset button S2.	Contactors K3 ... K6 are activated and the mirror contacts (N/C contacts of K3 ... K6) in the reset circuit are opened.	
Stop	Action	Result	Diagnostics
	1. Press emergency stop button S1.	The safety function is triggered and contactors K3 ... K6 are opened. In the reset circuit, the mirror contacts of K3 ... K6 are closed.	

For additional diagnostic descriptions, please refer to Section 7.

Notes on the application example

1. The emergency stop control device is positive opening according to EN 60947-5-1.
2. Contactors K3, K4, K5, and K6 have mirror contacts according to EN 60947-4-1.
3. Stop category 0 describes an immediate stop by removal of power by interrupting a machine or drive element according to EN 60204.
4. Install the safety relay and contactors together in an installation space according to EN 60204 (e.g., in the control cabinet). This prevents a cross circuit at the output of the safety relay.
5. When using the safety relay, take into consideration the maximum permissible number of cycles for observing the SIL/PL safety characteristics in the specific application. The safety characteristics can be found in the FUNCTIONAL SAFETY CHARACTERISTICS data sheet or the SISTEMA library.

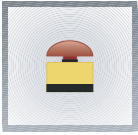

5.1.5 PSR-ESM4/3x1/1x2/B up to PL e/SIL 3

Two-channel emergency stop monitoring with manual reset
(with cross-circuit detection)

Order No.	2963776 with screw connection 2963925 with spring-cage connection
Technical data	<ul style="list-style-type: none"> - 24 V AC/DC - 3 enabling current paths, 1 signaling current path - Monitored manual reset - Basic insulation - Cat. 4/PL e according to EN ISO 13849-1, SIL CL 3 according to EN 62061

Application example

- Two-channel emergency stop monitoring
- Cross-circuit detection
- Ground fault detection (S11, S12 only)
- Manual reset (S33, S34)
- Feedback of contactor contacts K3 and K4 at S33 and S34
- Stop category 0
- Monitoring of external contactors
- Safety level of the example up to PL e (EN ISO 13849-1) and SIL 3 (EN 62061)

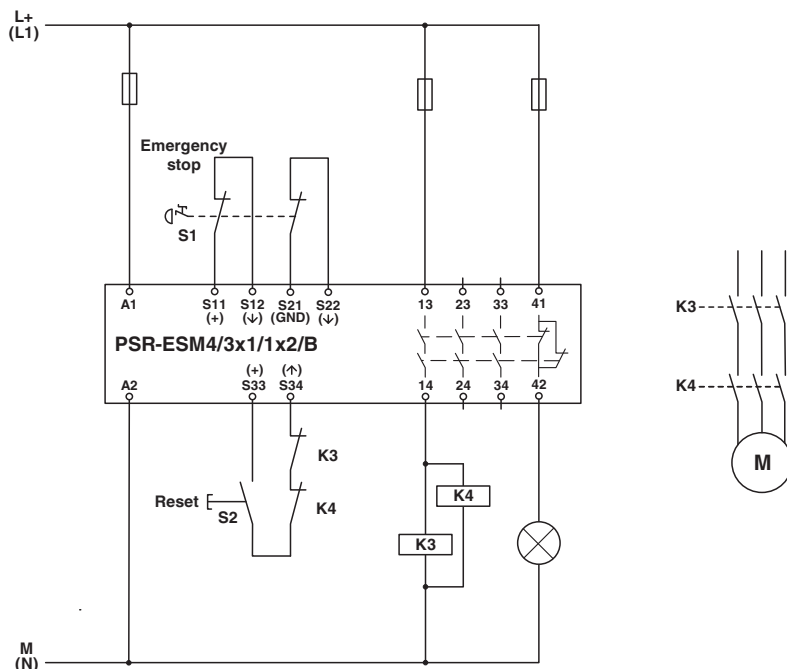





Figure 5-6 Two-channel emergency stop monitoring with manual reset
PSR-ESM4/3x1/1x2B

Function description

Start	Action	Result	Diagnostics
	1. Unlock emergency stop button S1.	The emergency stop button closes enable circuit S11, S12 and S21, S22 of the safety relay. The circuit is enabled via the reset button.	
	2. Press reset button S2.	Contactors K3 and K4 are activated and the mirror contacts (N/C contacts of K3 and K4) in the reset circuit are opened.	
Stop	Action	Result	Diagnostics
	1. Press emergency stop button S1.	The safety function is triggered and contactors K3 and K4 are opened. In the reset circuit, the mirror contacts of K3 and K4 are closed.	

For additional diagnostic descriptions, please refer to Section 7.

Notes on the application example

1. The emergency stop control device is positive opening according to EN 60947-5-1.
2. Contactors K3 and K4 have mirror contacts according to EN 60947-4-1.
3. Stop category 0 describes an immediate stop by removal of power by interrupting a machine or drive element according to EN 60204.
4. Install the safety relay and contactors together in an installation space according to EN 60204 (e.g., in the control cabinet). This prevents a cross circuit at the output of the safety relay.
5. When using the safety relay, take into consideration the maximum permissible number of cycles for observing the SIL/PL safety characteristics in the specific application. The safety characteristics can be found in the FUNCTIONAL SAFETY CHARACTERISTICS data sheet or the SISTEMA library.

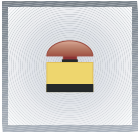

5.1.6 PSR-ESL4/3x1/1x2/B up to PL d/SIL 2

Two-channel emergency stop monitoring with manual reset

Order No.	2981059 with screw connection 2981062 with spring-cage connection
Technical data	<ul style="list-style-type: none"> - 24 V AC/DC - 3 enabling current paths, 1 signaling current path - Monitored manual or automatic start - Basic insulation - Cat. 4/PL e according to EN ISO 13849-1, SIL CL 3 according to EN 62061

Application example

- Two-channel emergency stop monitoring
- Manual reset (S33, S34)
- Feedback of contactor contacts K3 and K4 at S33 and S34
- Stop category 0
- Monitoring of external contactors
- Safety level of the example up to PL d (EN ISO 13849-1) and SIL 2 (EN 62061)

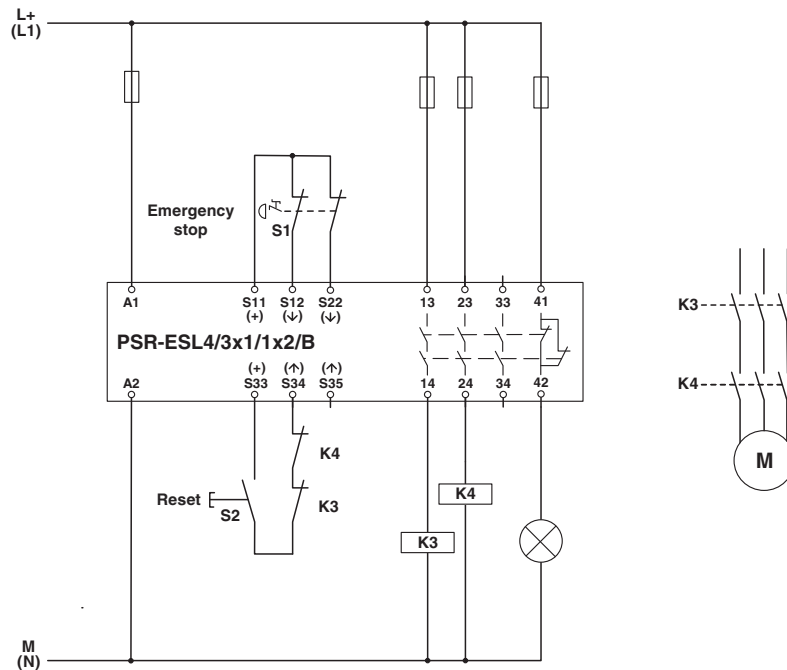

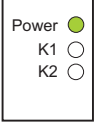

Figure 5-7 Two-channel emergency stop monitoring with manual reset PSR-ESL4/3x1/1x2/B

Function description

Start	Action	Result	Diagnostics
	1. Unlock emergency stop button S1.	The emergency stop button closes enable circuit S11, S12, and S22 of the safety relay. The circuit is enabled via the reset button.	
	2. Press reset button S2.	Contactors K3 and K4 are activated and the mirror contacts (N/C contacts of K3 and K4) in the reset circuit are opened.	
Stop	Action	Result	Diagnostics
	1. Press emergency stop button S1.	The safety function is triggered and contactors K3 and K4 are opened. In the reset circuit, the mirror contacts of K3 and K4 are closed.	

For additional diagnostic descriptions, please refer to Section 7.

Notes on the application example

1. The emergency stop control device is positive opening according to EN 60947-5-1.
2. Contactors K3 and K4 have mirror contacts according to EN 60947-4-1.
3. Stop category 0 describes an immediate stop by removal of power by interrupting a machine or drive element according to EN 60204.
4. When using the safety relay, take into consideration the maximum permissible number of cycles for observing the SIL/PL safety characteristics in the specific application. The safety characteristics can be found in the FUNCTIONAL SAFETY CHARACTERISTICS data sheet or the SISTEMA library.

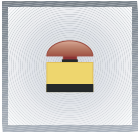

5.1.7 PSR-ESAM4/8x1/1x2 up to PL e/SIL 3

Two-channel emergency stop monitoring with manual reset
(with cross-circuit detection)

Order No.	2963912 with screw connection 2963996 with spring-cage connection
Technical data	<ul style="list-style-type: none"> - 24 V AC/DC - 8 enabling current paths, 1 signaling current path - Monitored manual or automatic start - Reinforced insulation/basic insulation - Cat. 4/PL e according to EN ISO 13849-1, SIL CL 3 according to EN 62061

Application example



- Two-channel emergency stop monitoring
- Cross-circuit detection
- Ground fault detection
- Manual reset (S33, S34)
- Feedback of contactor contacts K3, K4, K8, K9, K10, K11 at S33 and S34
- Stop category 0
- Monitoring of external contactors
- Safety level of the example up to PL e (EN ISO 13849-1) and SIL 3 (EN 62061)

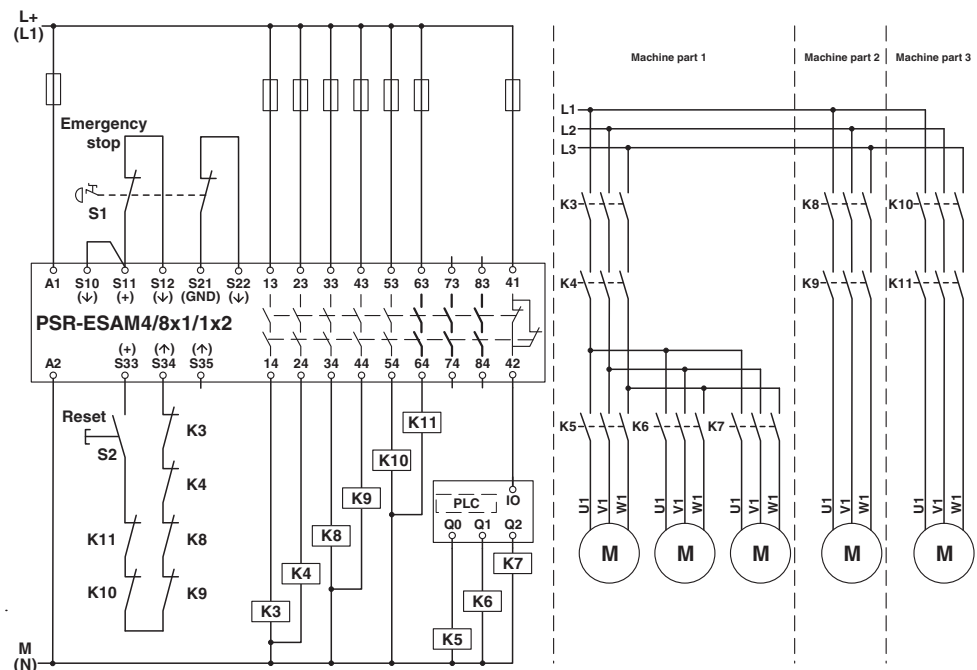





Figure 5-8 Two-channel emergency stop monitoring with manual reset
PSR-ESAM4/8x1/1x2

Function description

Start	Action	Result	Diagnostics
	1. Unlock emergency stop button S1.	The emergency stop button closes enable circuit S11, S12 and S21, S22 of the safety relay. The circuit is enabled via the reset button.	
	2. Press reset button S2.	Contactors K3, K4, K8, K9, K10, and K11 are activated and the mirror contacts (N/C contacts of K3, K4, K8, K9, K10, K11) in the reset circuit are opened. Once alarm contacts 41 and 42 of the safety relay have been opened, the PLC activates contactors K5, K6, and K7 depending on the user program. All three machine parts are activated.	
Stop	Action	Result	Diagnostics
	1. Press emergency stop button S1.	The safety function is triggered and machine parts 1 - 3 are deactivated. In the reset circuit, the mirror contacts of K3, K4, K8, K9, K10, and K11 are closed.	

For additional diagnostic descriptions, please refer to Section 7.

Notes on the application example

1. The emergency stop control device is positive opening according to EN 60947-5-1.
2. Contactors K3, K4, K8, K9, K10, and K11 have mirror contacts according to EN 60947-4-1.
3. Stop category 0 describes an immediate stop by removal of power by interrupting a machine or drive element according to EN 60204.
4. When using the safety relay, take into consideration the maximum permissible number of cycles for observing the SIL/PL safety characteristics in the specific application. The safety characteristics can be found in the FUNCTIONAL SAFETY CHARACTERISTICS data sheet or the SISTEMA library.

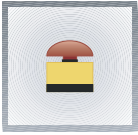

5.1.8 PSR-ESD/4x1/30 up to PL e/SIL 3

Two-channel emergency stop monitoring with delay contacts (with cross-circuit detection)

Order No.	2981800 with screw connection 2981813 with spring-cage connection
Technical data	<ul style="list-style-type: none"> - 24 V DC - 2 undelayed enabling current paths, 2 delayed enabling current paths - Adjustable delay time (0 ... 30 s) - Monitored manual or automatic start - Basic insulation - Cat. 4/PL e according to EN ISO 13849-1, SIL CL 3 according to EN 62061

Application example

- Two-channel emergency stop monitoring with controlled stop
- Cross-circuit detection
- Ground fault detection
- Manual reset (A1, S34)
- Feedback of contactor contacts K3 ... K5 at S34
- Stop category 1
- Monitoring of external contactors
- Safety level of the example up to PL e (EN ISO 13849-1) and SIL 3 (EN 62061)

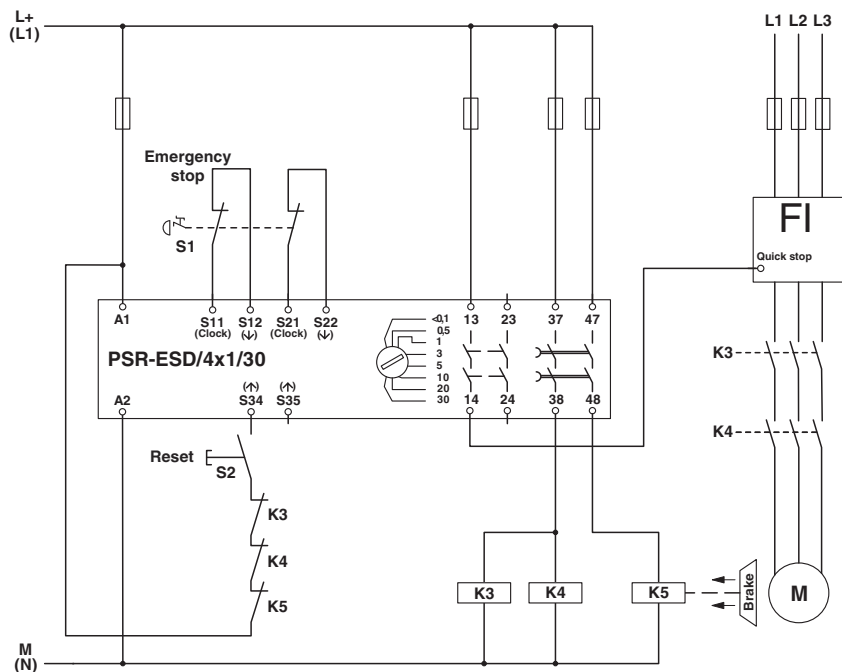
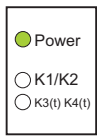





Figure 5-9 Two-channel emergency stop monitoring with delayed contacts PSR-ESD/4x1/30

Function description

Start	Action	Result	Diagnostics
	1. Unlock emergency stop button S1.	The emergency stop button closes enable circuit S11, S12 and S21, S22 of the safety relay. The circuit is enabled via the reset button.	
	2. Press reset button S2.	Contactors K3 ... K5 are activated and the mirror contacts (N/C contacts of K3 ... K5) in the reset circuit are opened.	
Stop	Action	Result	Diagnostics
	1. Press emergency stop button S1.	The safety function is triggered and contacts 13, 14 of the safety relay open immediately, which initiates an automatic "quick stop" at the FI.	
		After the preset time has elapsed, delay contacts 37, 38 and 47, 48 deactivate the three contactors K3 ... K5 with a time delay. After the delayed deactivation, parallel to the motor the mains supply is disconnected from the FI and brake unlocking is switched off so that the brake blocks the drive. In the reset circuit, the mirror contacts of K3 ... K5 are closed.	

For additional diagnostic descriptions, please refer to Section 7.

Notes on the application example

1. The emergency stop control device is positive opening according to EN 60947-5-1.
2. Contactors K3, K4, and K5 have mirror contacts according to EN 60947-4-1.
3. Stop category 1 describes a controlled stop with power available according to EN 60204. This means that the power is only switched off after the connected machine has stopped.
4. The brake is not part of the safety function.
5. Install the safety relay, FI, and contactors together in an installation space according to EN 60204 (e.g., in the control cabinet). This prevents a cross circuit at the output of the safety relay.
6. When using the safety relay, take into consideration the maximum permissible number of cycles for observing the SIL/PL safety characteristics in the specific application. The safety characteristics can be found in the FUNCTIONAL SAFETY CHARACTERISTICS data sheet or the SISTEMA library.

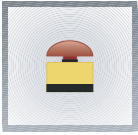

5.1.9 PSR-ESAM4/3x1/1x2/B up to PL e/SIL 3

Two-channel cable-operated switch monitoring with manual reset (with cross-circuit detection)

Order No.	2900509 with screw connection 2900510 with spring-cage connection
Technical data	<ul style="list-style-type: none"> - 24 V AC/DC - 3 enabling current paths, 1 signaling current path - Monitored manual or automatic start - Basic insulation - Cat. 4/PL e according to EN ISO 13849-1, SIL CL 3 according to EN 62061

Application example

- Two-channel cable-operated switch monitoring
- Cross-circuit detection
- Ground fault detection
- Manual reset (S12, S34)
- Feedback of contactor contacts K3 and K4 at S34
- Stop category 0
- Monitoring of external contactors
- Safety level of the example up to PL e (EN ISO 13849-1) and SIL 3 (EN 62061)

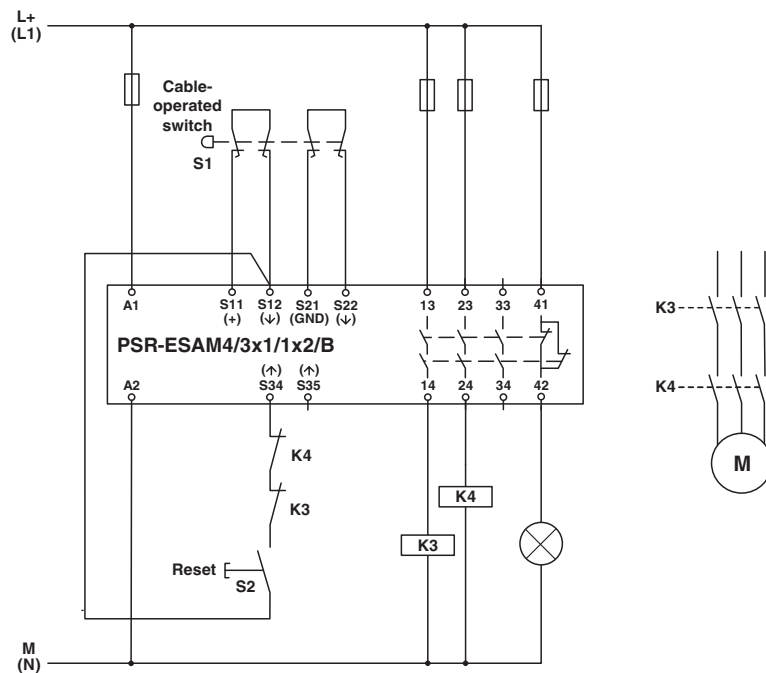

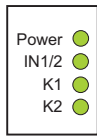
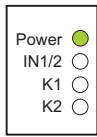

Figure 5-10 Two-channel cable-operated switch monitoring with manual reset PSR-ESAM4/3x1/1x2/B

Function description

Start	Action	Result	Diagnostics
	1. Cable-operated switch S1 is not activated.	The cable-operated switch closes enable circuit S11, S12 and S21, S22 of the safety relay. The circuit is enabled via the reset button.	
	2. Press reset button S2.	Contactors K3 and K4 are activated and the mirror contacts (N/C contacts of K3 and K4) in the reset circuit are opened.	
Stop	Action	Result	Diagnostics
	1. Pull cable-operated switch S1.	The safety function is triggered and contactors K3 and K4 are opened. In the reset circuit, the mirror contacts of K3 and K4 are closed.	

For additional diagnostic descriptions, please refer to Section 7.

Notes on the application example

1. The cable-operated switch is positive opening according to EN 60947-5-1.
2. Contactors K3 and K4 have mirror contacts according to EN 60947-4-1.
3. Stop category 0 describes an immediate stop by removal of power by interrupting a machine or drive element according to EN 60204.
4. When using the safety relay, take into consideration the maximum permissible number of cycles for observing the SIL/PL safety characteristics in the specific application. The safety characteristics can be found in the FUNCTIONAL SAFETY CHARACTERISTICS data sheet or the SISTEMA library.

5.2 Light grids (ESPE)/laser scanners (AOPD)

Light grids

Light grids consist of a transmit and receive unit and have a two-dimensional monitoring range. Light grids are electro-sensitive protective elements used to protect operating personnel working on or in the vicinity of dangerous machines. Compared to mechanical systems, they offer the advantage of contact-free and therefore wear-free operation.

Please note the following factors when using light grids:

- The light grids must be installed in such a way that it is impossible to access the protected field from above, below or behind. If this is not guaranteed, additional safety equipment must be installed.
- The machine control system must be capable of being influenced electrically and permit dangerous states to be exited immediately in each operating phase.
- The ambient conditions must not adversely affect the effectiveness of the light protective system.
- Electro-sensitive protective equipment (ESPE) does not provide protection from flying parts.

Relevant standards

EN 61496-1, EN 61496-2: Requirements for electro-sensitive protective systems

EN ISO 13855: Positioning of safeguards with respect to the approach speeds of parts of the human body

Laser scanners

Laser scanners scan the shape of the environment like a type of optical radar. The distance to an object is determined by a runtime measurement. A mirror integrated in the devices is used to achieve two-dimensional scanning. The protected fields that are used for shutdown in the event of a hazardous situation can be defined using software. As the distance increases, the resolution of the scanner decreases and this therefore affects the required minimum distance.

Examples of use

- Protection of the danger zone for presses
- Protection of the danger zone for production cells
- Back step protection for insert areas of robot cells

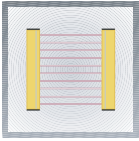

5.2.1 PSR-ESL4/3x1/1x2/B up to PL e/SIL 3

Two-channel light grid monitoring with manual reset (ESPE type 4)

Order No.	2981059 with screw connection 2981062 with spring-cage connection
Technical data	<ul style="list-style-type: none"> - 24 V AC/DC - 3 enabling current paths, 1 signaling current path - Monitored manual or automatic start - Basic insulation - Cat. 4/PL e according to EN ISO 13849-1, SIL CL 3 according to EN 62061

Application example

- Two-channel light grid monitoring
- Cross-circuit detection via the light grid
- Manual reset (S33, S34)
- Feedback of contactor contacts K3 and K4 at S34
- Stop category 0
- Monitoring of external contactors
- Safety level of the example up to PL e (EN ISO 13849-1) and SIL 3 (EN 62061)

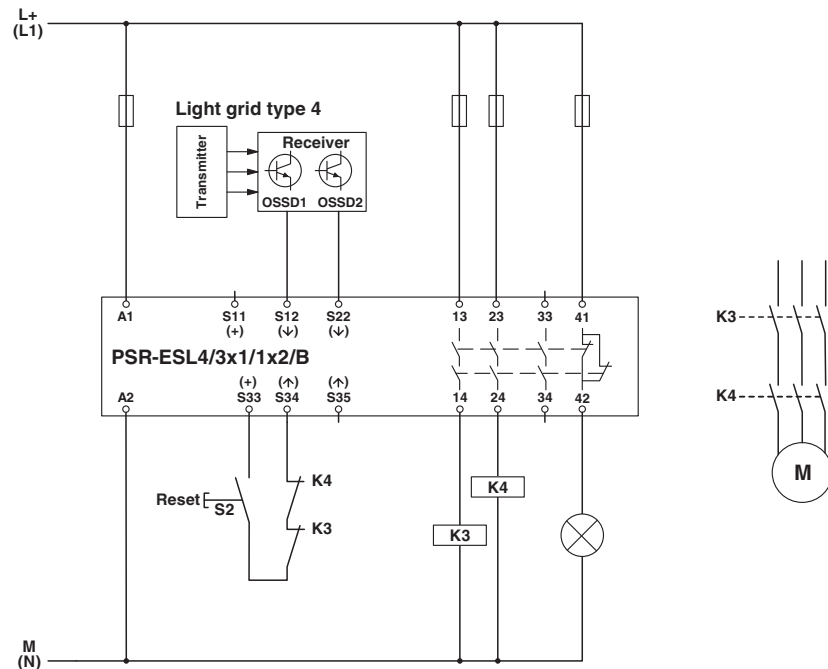
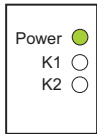



Figure 5-11 Two-channel light grid monitoring with manual reset PSR-ESL4/3x1/1x2/B

Function description

Start	Action	Result	Diagnostics
	1. The light grid is active, there is no object in the protected field.	Both OSSD signals from the light grid provide high signals to enable circuit S12 and S22 of the safety relay. The circuit is enabled via the reset button.	
	2. Press reset button S2.	Contactors K3 and K4 are activated and the mirror contacts (N/C contacts of K3 and K4) in the reset circuit are opened.	
Stop	Action	Result	Diagnostics
	1. The light grid is interrupted, there is an object in the protected field.	The safety function is triggered by the interruption of the light grid and contactors K3 and K4 are opened. In the reset circuit, the mirror contacts of K3 and K4 are closed.	

For additional diagnostic descriptions, please refer to Section 7.

Notes on the application example

1. The light grid (ESPE) must meet type 4 requirements from standard EN 61496-1.
2. Contactors K3 and K4 have mirror contacts according to EN 60947-4-1.
3. Stop category 0 describes an immediate stop by removal of power by interrupting a machine or drive element according to EN 60204.
4. When using the safety relay, take into consideration the maximum permissible number of cycles for observing the SIL/PL safety characteristics in the specific application. The safety characteristics can be found in the FUNCTIONAL SAFETY CHARACTERISTICS data sheet or the SISTEMA library..

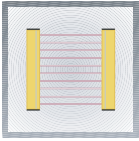

5.2.2 PSR-ESD/4x1/30 up to PL e/SIL 3

Two-channel light grid monitoring with manual reset (ESPE type 4)

Order No.	2981800 with screw connection 2981813 with spring-cage connection
Technical data	<ul style="list-style-type: none"> - 24 V DC - 2 undelayed enabling current paths, 2 delayed enabling current paths - Adjustable delay time (0 ... 30 s) - Manual or automatic start - Basic insulation - Cat. 4/PL e according to EN ISO 13849-1, SIL CL 3 according to EN 62061

Application example

- Two-channel light grid monitoring
- Cross-circuit detection via the light grid
- Manual reset (A1, S34)
- Feedback of contactor contacts K3 and K4 at S34
- Stop category 0
- Monitoring of external contactors
- Safety level of the example up to PL e (EN ISO 13849-1) and SIL 3 (EN 62061)

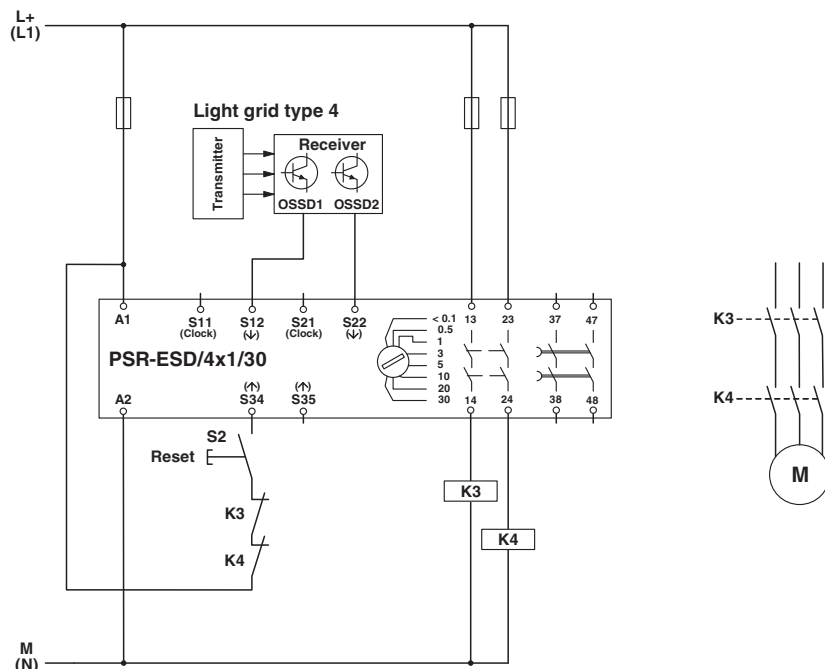





Figure 5-12 Two-channel light grid monitoring with manual reset PSR-ESD/4x1/30

Function description

Start	Action	Result	Diagnostics
	1. The light grid is active, there is no object in the protected field.	Both OSSD signals from the light grid provide high signals to enable circuit S12 and S22 of the safety relay. The circuit is enabled via the reset button.	
	2. Press reset button S2.	Contactors K3 and K4 are activated and the mirror contacts (N/C contacts of K3 and K4) in the reset circuit are opened.	
Stop	Action	Result	Diagnostics
	1. The light grid is interrupted, there is an object in the protected field.	The safety function is triggered by the interruption of the light grid and contactors K3 and K4 are opened. In the reset circuit, the mirror contacts of K3 and K4 are closed.	
		After the preset time has elapsed, the delayed enable contacts of the safety relay are opened.	

For additional diagnostic descriptions, please refer to Section 7.

Notes on the application example

1. The light grid (ESPE) must meet type 4 requirements from standard EN 61496-1.
2. Contactors K3 and K4 have mirror contacts according to EN 60947-4-1.
3. Stop category 0 describes an immediate stop by removal of power by interrupting a machine or drive element according to EN 60204.
4. When using the safety relay, take into consideration the maximum permissible number of cycles for observing the SIL/PL safety characteristics in the specific application. The safety characteristics can be found in the FUNCTIONAL SAFETY CHARACTERISTICS data sheet or the SISTEMA library.

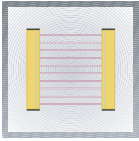

5.2.3 PSR-ESAM4/8x1/1x2 up to PL e/SIL 3

Two-channel light grid monitoring with automatic reset (ESPE type 4)

Order No.	2963912 with screw connection 2963996 with spring-cage connection
Technical data	<ul style="list-style-type: none"> - 24 V AC/DC - 8 enabling current paths, 1 signaling current path - Monitored manual or automatic start - Reinforced insulation/basic insulation - Cat. 4/PL e according to EN ISO 13849-1, SIL CL 3 according to EN 62061

Application example

- Two-channel light grid monitoring
- Cross-circuit detection via the light grid
- Manual reset (S33, S35)
- Feedback of contactor contacts K3 and K4 at S33 and S35
- Stop category 0
- Monitoring of external contactors
- Safety level of the example up to PL e (EN ISO 13849-1) and SIL 3 (EN 62061)

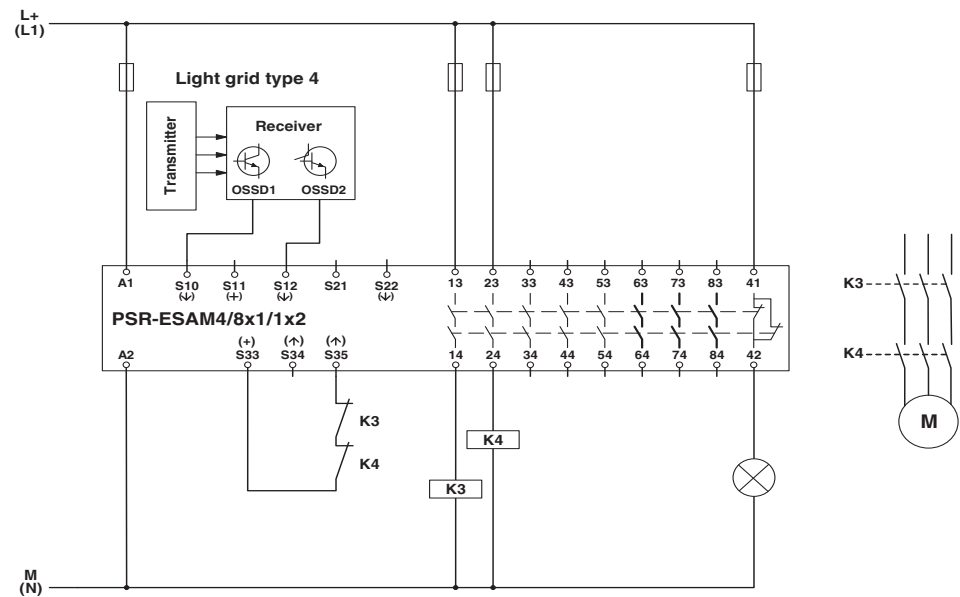
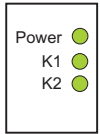
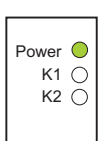

Figure 5-13 Two-channel light grid monitoring with automatic reset PSR-ESAM4/8x1/1x2

Function description

Start	Action	Result	Diagnostics
	1. The light grid is active, there is no object in the protected field.	Both OSSD signals from the light grid provide high signals to enable circuit S10 and S12 of the safety relay. Contactors K3 and K4 are activated and the mirror contacts (N/C contacts of K3 and K4) in the reset circuit are opened.	
Stop	Action	Result	Diagnostics
	1. The light grid is interrupted, there is an object in the protected field.	The safety function is triggered by the interruption of the light grid and contactors K3 and K4 are opened. In the reset circuit, the mirror contacts of K3 and K4 are closed.	

For additional diagnostic descriptions, please refer to Section 7.

Notes on the application example

1. The light grid (ESPE) must meet type 4 requirements from standard EN 61496-1.
2. Contactors K3 and K4 have mirror contacts according to EN 60947-4-1.
3. Stop category 0 describes an immediate stop by removal of power by interrupting a machine or drive element according to EN 60204.
4. A restart should only occur automatically if there is no hazardous situation. Please refer to the detailed information in standard EN ISO 12100 (6.3.3.2.5).
5. When using the safety relay, take into consideration the maximum permissible number of cycles for observing the SIL/PL safety characteristics in the specific application. The safety characteristics can be found in the FUNCTIONAL SAFETY CHARACTERISTICS data sheet or the SISTEMA library.

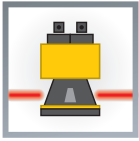

5.2.4 PSR-ESD/4x1/30 up to PL d/SIL 2

Two-channel laser scanner monitoring with manual reset (ESPE type 3)

Order No.	2981800 with screw connection 2981813 with spring-cage connection
Technical data	<ul style="list-style-type: none"> - 24 V AC/DC - 2 undelayed enabling current paths, 2 delayed enabling current paths - Monitored manual or automatic start - Basic insulation - Cat. 4/PL e according to EN ISO 13849-1, SIL CL 3 according to EN 62061

Application example

- Two-channel laser scanner monitoring
- Cross-circuit detection via laser scanner
- Manual reset (A1, S34)
- Feedback of contactor contacts K3 and K4 at S34
- Stop category 0
- Monitoring of external contactors
- Safety level of the example up to PL d (EN ISO 13849-1) and SIL 2 (EN 62061)

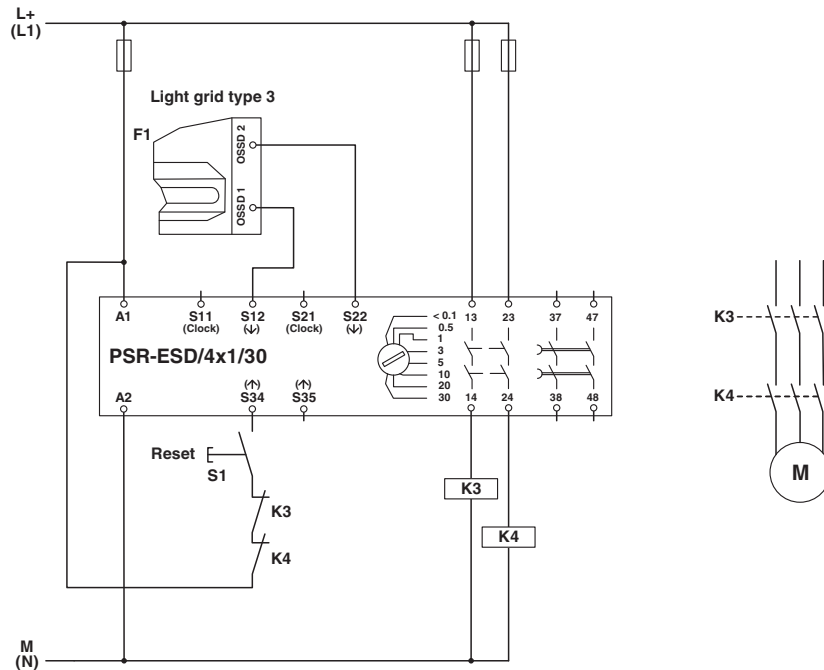





Figure 5-14 Two-channel laser scanner monitoring with manual reset PSR-ESD/4x1/30

Function description

Start	Action	Result	Diagnostics
	1. The laser scanner is active, there is no object in the protected field.	Both OSSD signals from the laser scanner provide high signals to enable circuit S12 and S22 of the safety relay. The circuit is enabled via the reset button.	
	2. Press reset button S1.	Contactors K3 and K4 are activated and the mirror contacts (N/C contacts of K3 and K4) in the reset circuit are opened.	
Stop	Action	Result	Diagnostics
	1. The laser scanner is interrupted, there is an object in the protected field.	The safety function is triggered by the interruption of the laser scanner and contactors K3 and K4 are opened. In the reset circuit, the mirror contacts of K3 and K4 are closed.	
		After the preset time has elapsed, the delayed enable contacts of the safety relay are opened.	

For additional diagnostic descriptions, please refer to Section 7.

Notes on the application example

1. The laser scanner must meet type 3 requirements from standard EN 61496-3.
2. Contactors K3 and K4 have mirror contacts according to EN 60947-4-1.
3. Stop category 0 describes an immediate stop by removal of power by interrupting a machine or drive element according to EN 60204.
4. When using the safety relay, take into consideration the maximum permissible number of cycles for observing the SIL/PL safety characteristics in the specific application. The safety characteristics can be found in the FUNCTIONAL SAFETY CHARACTERISTICS data sheet or the SISTEMA library.

5.3 Movable guards

Guards with an interlocking device are designed for executing the following functions together with the machine control system:

- The hazardous machine functions “covered” by the guard cannot be performed until the guard is closed.
- If the guard is opened while the hazardous machine functions are operating, a stop command is triggered.
- The hazardous machine functions “covered” by the guard can be performed as soon as the guard is closed. Closing the guard does not automatically initiate the hazardous machine functions.

Interlocking devices can combine various functions and have a position monitoring function for guards. The interlocking device detects whether or not the guard is closed and issues a stop command. Some interlocking devices have a guard locking function which locks the guard while the hazardous machine functions are performed. A separate status monitoring function for guard locking devices monitors whether the guard locking device is locked and generates a corresponding output signal.

Relevant standards:

- EN 1088 Safety of machinery - Interlocking devices associated with guards.
- prEN 14119 Safety of machinery - Interlocking devices associated with guards.

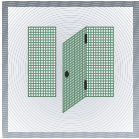

5.3.1 PSR-ESA4/2x1/1x2 up to PL e/SIL 3

Two-channel safety door monitoring with automatic reset (with cross-circuit detection)

Order No.	2963750 with screw connection 2963938 with spring-cage connection
Technical data	<ul style="list-style-type: none"> - 24 V AC/DC - 2 enabling current paths, 1 signaling current path - Manual or automatic start - Reinforced insulation - Cat. 4/PL e according to EN ISO 13849-1, SIL CL 3 according to EN 62061

Application example



- Two-channel safety door monitoring with two position switches
- Cross-circuit detection
- Ground fault detection (S11, S12 only)
- Automatic reset (bridge S33, S34)
- Feedback of contactor contacts K3 and K4 at S33 and S34
- Stop category 0
- Monitoring of external contactors
- Safety level of the example up to PL e (EN ISO 13849-1) and SIL 3 (EN 62061)

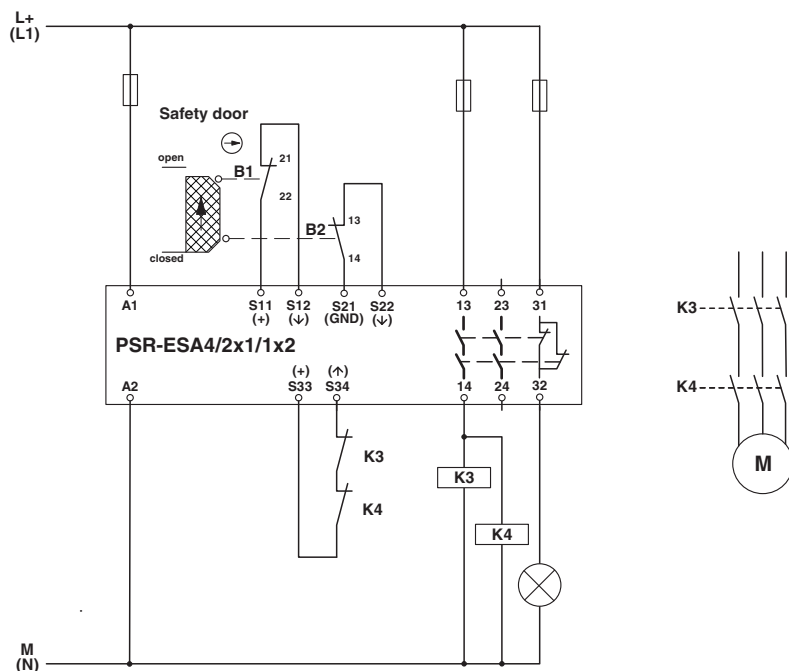

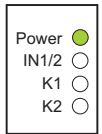

Figure 5-15 Two-channel safety door monitoring with automatic reset PSR-ESA4/2x1/1x2

Function description

Start	Action	Result	Diagnostics
	1. Close the safety door.	The safety door circuit closes enable circuit S11, S12 and S21, S22 of the safety relay. Contactors K3 and K4 are activated and the mirror contacts (N/C contacts of K3 and K4) in the reset circuit are opened.	
Stop	Action	Result	Diagnostics
	1. Open the safety door.	The safety function is triggered and contactors K3 and K4 are opened. In the reset circuit, the mirror contacts of K3 and K4 are closed.	

For additional diagnostic descriptions, please refer to Section 7.

Notes on the application example

1. The position switch is positive opening according to EN 60947-5-1.
2. Contactors K3 and K4 have mirror contacts according to EN 60947-4-1.
3. Stop category 0 describes an immediate stop by removal of power by interrupting a machine or drive element according to EN 60204.
4. A restart should only occur automatically if there is no hazardous situation. Please refer to the detailed information in standard EN ISO 12100 (6.3.3.2.5).
5. Install the safety relay and contactors together in an installation space according to EN 60204 (e.g., in the control cabinet). This prevents a cross circuit at the output of the safety relay.
6. When using the safety relay, take into consideration the maximum permissible number of cycles for observing the SIL/PL safety characteristics in the specific application. The safety characteristics can be found in the FUNCTIONAL SAFETY CHARACTERISTICS data sheet or the SISTEMA library.

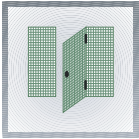

5.3.2 PSR-ESAM4/2x1/1x2 up to PL e/SIL 3

Two-channel safety door monitoring with manual reset
(with cross-circuit detection)

Order No.	2900525 with screw connection 2900526 with spring-cage connection
Technical data	<ul style="list-style-type: none"> - 24 V AC/DC - 2 enabling current paths, 1 signaling current path - Manual or automatic start - Reinforced insulation - Cat. 4/PL e according to EN ISO 13849-1, SIL CL 3 according to EN 62061

Application example

- Two-channel safety door monitoring with one safety hinge switch
- Cross-circuit detection
- Ground fault detection (S11, S12 only)
- Manual reset (S12, S34)
- Feedback of contactor contacts K3 and K4 at S34
- Stop category 0
- Monitoring of external contactors
- Safety level of the example up to PL e (EN ISO 13849-1) and SIL 3 (EN 62061)

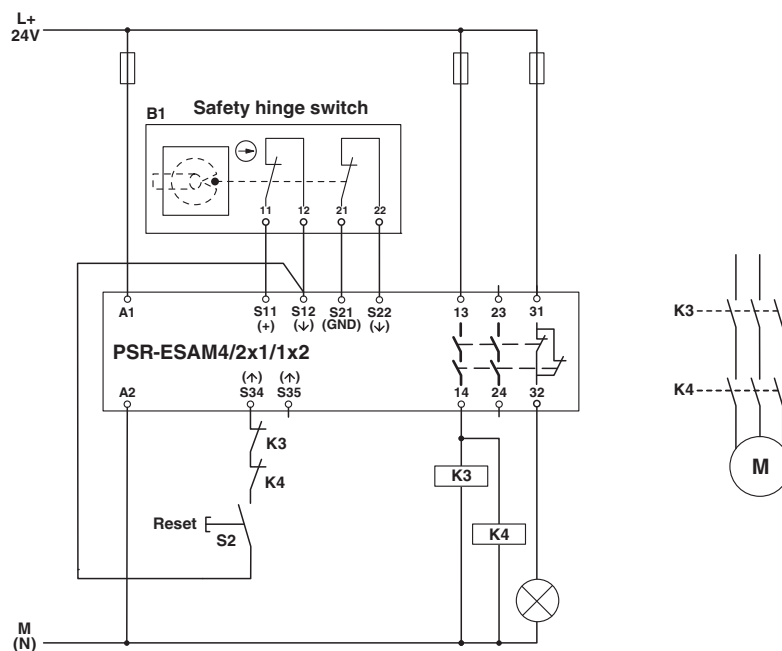

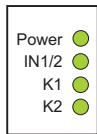
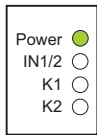

Figure 5-16 Two-channel safety door monitoring with manual reset PSR-ESAM4/2x1

Function description

Start	Action	Result	Diagnostics
	1. Close the safety door.	The safety door circuit closes enable circuit S11, S12 and S21, S22 of the safety relay. The circuit is enabled via the reset button.	
	2. Press reset button S2.	Contactors K3 and K4 are activated and the mirror contacts (N/C contacts of K3 and K4) in the reset circuit are opened.	
Stop	Action	Result	Diagnostics
	1. Open the safety door.	The safety function is triggered and contactors K3 and K4 are opened. In the reset circuit, the mirror contacts of K3 and K4 are closed.	

For additional diagnostic descriptions, please refer to Section 7.

Notes on the application example

1. When using safety hinge switches, observe the notes in standards EN 953, EN 1088, EN ISO 13857, and EN ISO 14119.
2. Contactors K3 and K4 have mirror contacts according to EN 60947-4-1.
3. Stop category 0 describes an immediate stop by removal of power by interrupting a machine or drive element according to EN 60204.
4. Install the safety relay and contactors together in an installation space according to EN 60204 (e.g., in the control cabinet). This prevents a cross circuit at the output of the safety relay.
5. When using the safety relay, take into consideration the maximum permissible number of cycles for observing the SIL/PL safety characteristics in the specific application. The safety characteristics can be found in the FUNCTIONAL SAFETY CHARACTERISTICS data sheet or the SISTEMA library.

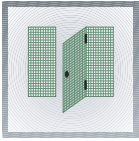

5.3.3 PSR-ESAM4/3x1/1x2 up to PL e/SIL 3

Two-channel safety door monitoring with manual reset (with cross-circuit detection)

Order No.	2981114 with screw connection 2981127 with spring-cage connection
Technical data	<ul style="list-style-type: none"> - 24 - 230 V AC/DC - 3 enabling current paths, 1 signaling current path - Manual or automatic start - Reinforced insulation - Cat. 4/PL e according to EN ISO 13849-1, SIL CL 3 according to EN 62061

Application example

- Two-channel safety door monitoring with two position switches
- Cross-circuit detection
- Ground fault detection (S11, S12 only)
- Manual reset (S33, S34)
- Feedback of contactor contacts K3 and K4 at S33 and S34
- Stop category 0
- Monitoring of external contactors
- Safety level of the example up to PL e (EN ISO 13849-1) and SIL 3 (EN 62061)

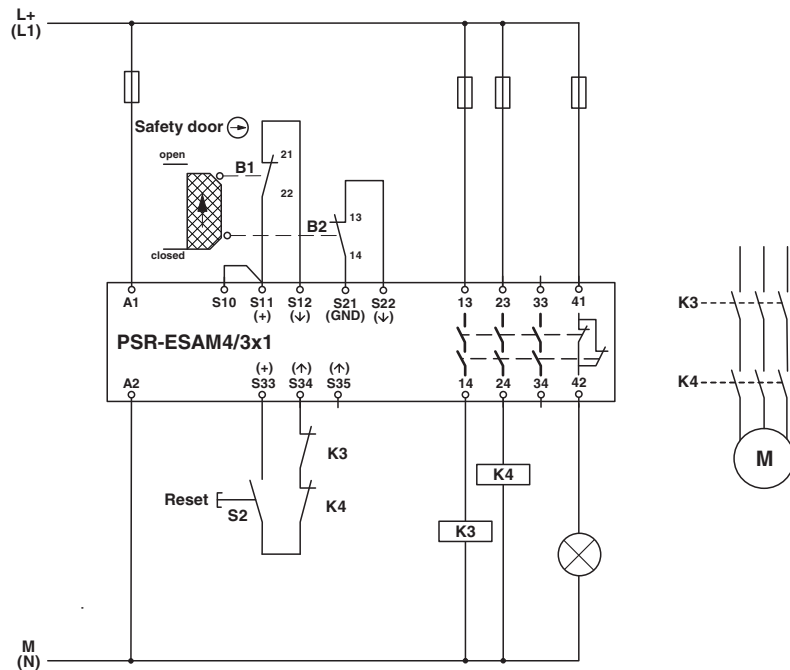
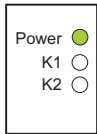



Figure 5-17 Two-channel safety door monitoring with manual reset PSR-ESAM4/3x1

Function description

Start	Action	Result	Diagnostics
	1. Close the safety door.	The safety door circuit closes enable circuit S11, S12 and S21, S22 of the safety relay. The circuit is enabled via the reset button.	
	2. Press reset button S2.	Contactors K3 and K4 are activated and the mirror contacts (N/C contacts of K3 and K4) in the reset circuit are opened.	
Stop	Action	Result	Diagnostics
	1. Open the safety door.	The safety function is triggered and contactors K3 and K4 are opened. In the reset circuit, the mirror contacts of K3 and K4 are closed.	

For additional diagnostic descriptions, please refer to Section 7.

Notes on the application example

1. The position switch is positive opening according to EN 60947-5-1.
2. Contactors K3 and K4 have mirror contacts according to EN 60947-4-1.
3. Stop category 0 describes an immediate stop by removal of power by interrupting a machine or drive element according to EN 60204.
4. When using the safety relay, take into consideration the maximum permissible number of cycles for observing the SIL/PL safety characteristics in the specific application. The safety characteristics can be found in the FUNCTIONAL SAFETY CHARACTERISTICS data sheet or the SISTEMA library.

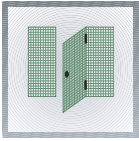

5.3.4 PSR-ESAM4/3x1/1x2/B up to PL d/SIL 2

Two-channel safety door monitoring with manual reset
(with cross-circuit detection)

Order No.	2900509 with screw connection 2900510 with spring-cage connection
Technical data	<ul style="list-style-type: none"> - 24 V AC/DC - 3 enabling current paths, 1 signaling current path - Manual or automatic start - Basic insulation - Cat. 4/PL e according to EN ISO 13849-1, SIL CL 3 according to EN 62061

Application example

- Two-channel safety door monitoring with guard locking
- Cross-circuit detection
- Ground fault detection (S11, S12 only)
- Manual reset (S12, S34)
- Feedback of contactor contacts K3 and K4 at S34
- Stop category 0
- Monitoring of external contactors
- Safety level of the example up to PL d (EN ISO 13849-1) and SIL 2 (EN 62061)

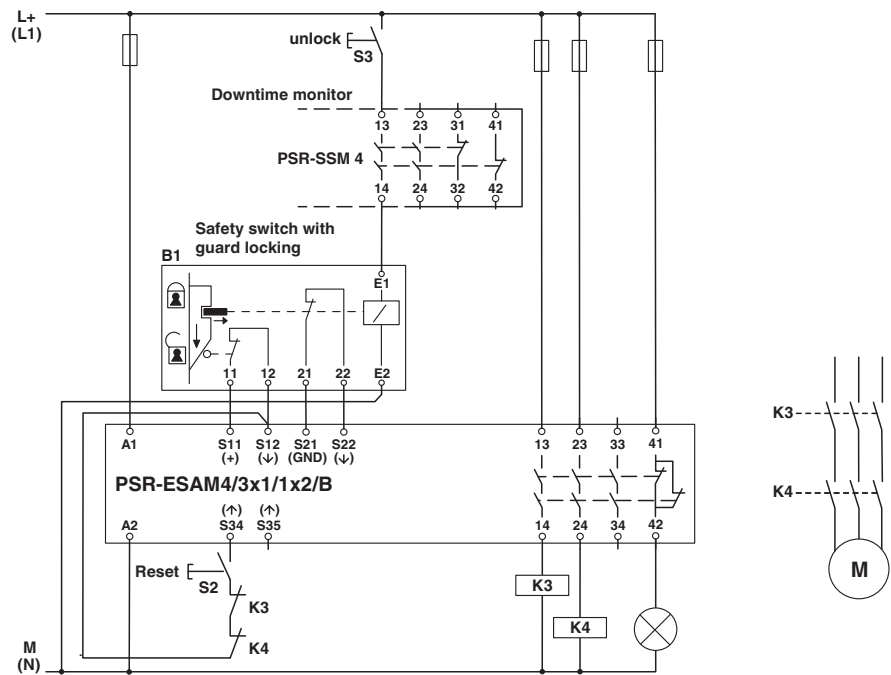

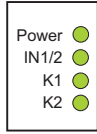



Figure 5-18 Two-channel safety door monitoring with manual reset PSR-ESAM4/3x1B

Function description

Start	Action	Result	Diagnostics
	1. Close and lock the safety door.	The safety door circuit closes enable circuit S11, S12 and S21, S22 of the safety relay. The circuit is enabled via the reset button.	
	2. Press reset button S2.	Contactors K3 and K4 are activated and the mirror contacts (N/C contacts of K3 and K4) in the reset circuit are opened.	
Stop	Action	Result	Diagnostics
	1. Unlock guard locking B1 via button S3. 2. Open the safety door.	The safety function is triggered and contactors K3 and K4 are opened. In the reset circuit, the mirror contacts of K3 and K4 are closed.	

For additional diagnostic descriptions, please refer to Section 7.

Notes on the application example

1. The safety guard locking is positive opening according to EN 60947-5-1.
2. Contactors K3 and K4 have mirror contacts according to EN 60947-4-1.
3. Stop category 0 describes an immediate stop by removal of power by interrupting a machine or drive element according to EN 60204.
4. When using the safety relay, take into consideration the maximum permissible number of cycles for observing the SIL/PL safety characteristics in the specific application. The safety characteristics can be found in the FUNCTIONAL SAFETY CHARACTERISTICS data sheet or the SISTEMA library.

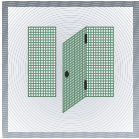

5.3.5 PSR-ESD/4x1/30 up to PL d/SIL 2

Two-channel safety door monitoring with delay contacts and automatic reset (with cross-circuit detection)

Order No.	2981800 with screw connection 2981813 with spring-cage connection
Technical data	<ul style="list-style-type: none"> - 24 V DC - 2 undelayed enabling current paths, 2 delayed enabling current paths - Adjustable delay time (0 ... 30 s) - Manual or automatic start - Basic insulation - Cat. 4/PL e according to EN ISO 13849-1, SIL CL 3 according to EN 62061

Application example

- Two-channel safety door monitoring with two position switches and controlled stop
- Cross-circuit detection/ground fault detection
- Automatic reset (A1, S35)
- Feedback of contactor contacts K3 and K4 at S35
- Stop category 1
- Monitoring of external contactors
- Safety level of the example up to PL d (EN ISO 13849-1) and SIL 2 (EN 62061)

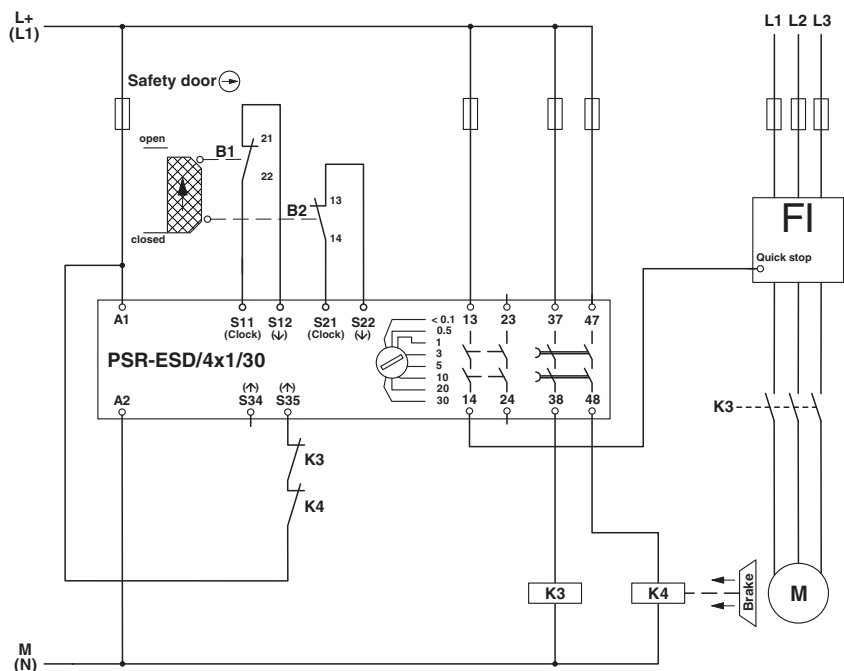

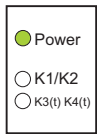

Figure 5-19 Two-channel safety door monitoring with delayed contacts and automatic reset PSR-ESD/4x1/30

Function description

Start	Action	Result	Diagnostics
	1. Close the safety door.	The safety door circuit closes enable circuit S11, S12 and S21, S22 of the safety relay. Contactors K3 and K4 are activated and the mirror contacts (N/C contacts of K3 and K4) in the reset circuit are opened.	
Stop	1. Open the safety door.	The safety door is opened and contacts 13, 14 of the safety relay open immediately, which initiates an automatic "quick stop" at the FI.	
		After the preset time has elapsed, delay contacts 37, 38 and 47, 48 deactivate contactors K3 and K4 with a time delay. After the delayed deactivation, parallel to the motor the mains supply is disconnected from the FI and brake unlocking is switched off so that the brake blocks the drive. In the reset circuit, the mirror contacts of K3 and K4 are closed.	

For additional diagnostic descriptions, please refer to Section 7.

Notes on the application example

1. The position switch is positive opening according to EN 60947-5-1.
2. Contactors K3 and K4 have mirror contacts according to EN 60947-4-1.
3. Stop category 1 describes a controlled stop with power available according to EN 60204. This means that the power is only switched off after the connected machine has stopped.
4. A restart should only occur automatically if there is no hazardous situation. Please refer to the detailed information in standard EN ISO 12100 (6.3.3.2.5).
5. The (holding) brake is not part of the safety function.
6. When the safety door has been opened, it should not be possible to access the danger zones during the controlled stop of the hazardous movement (observe safety distance).
7. Install the safety relay and contactors together in an installation space according to EN 60204 (e.g., in the control cabinet). This prevents a cross circuit at the output of the safety relay.
8. When using the safety relay, take into consideration the maximum permissible number of cycles for observing the SIL/PL safety characteristics in the specific application. The safety characteristics can be found in the FUNCTIONAL SAFETY CHARACTERISTICS data sheet or the SISTEMA library.

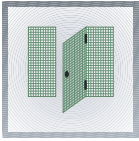

5.3.6 PSR-ESD/4x1/30 up to PL e/SIL 3

Two-channel safety door monitoring with delay contacts and manual reset (with cross-circuit detection)

Order No.	2981800 with screw connection 2981813 with spring-cage connection
Technical data	<ul style="list-style-type: none"> - 24 V DC - 2 undelayed enabling current paths, 2 delayed enabling current paths - Adjustable delay time (0 ... 30 s) - Monitored manual or automatic start - Basic insulation - Cat. 4/PL e according to EN ISO 13849-1, SIL CL 3 according to EN 62061

Application example

- Two-channel contact-free safety switch
- Cross-circuit detection via contact-free safety switch
- Manual reset (A1, S34)
- Feedback of contactor contacts K3 and K4 at S34
- Stop category 0
- Monitoring of external contactors
- Safety level of the example up to PL e (EN ISO 13849-1) and SIL 3 (EN 62061)

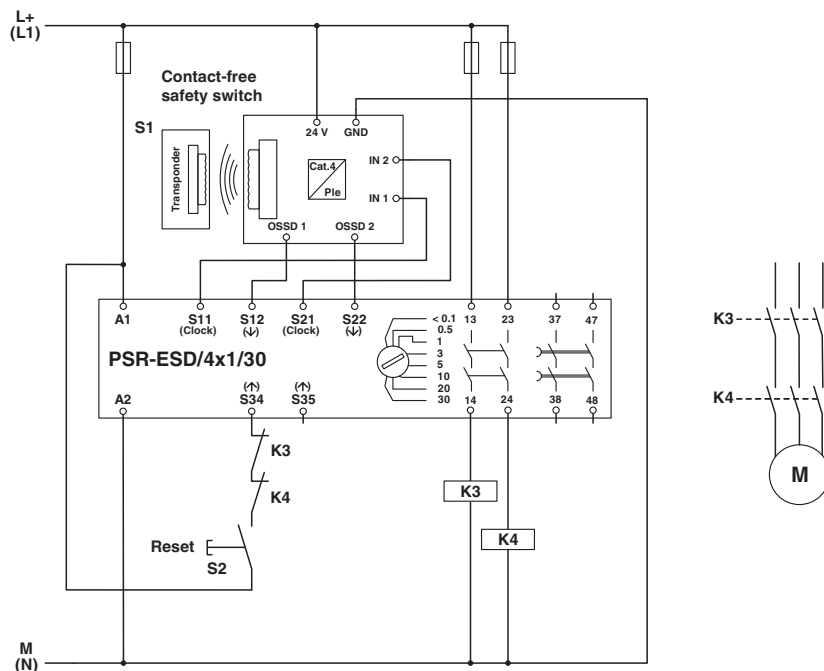





Figure 5-20 Two-channel safety door monitoring with delayed contacts and manual reset PSR-ESD/4x1/30

Function description

Start	Action	Result	Diagnostics
	1. Close the safety door.	The safety door circuit closes enable circuit S12 and S22 of the safety relay.	
	2. Press reset button S2.	Contactors K3 and K4 are activated and the mirror contacts (N/C contacts of K3 and K4) in the reset circuit are opened.	
Stop	Action	Result	Diagnostics
	1. Open the safety door.	The safety function is triggered and contactors K3 and K4 are opened. In the reset circuit, the mirror contacts of K3 and K4 are closed.	
		After the preset time has elapsed, the delayed enable contacts of the safety relay are opened.	

For additional diagnostic descriptions, please refer to Section 7.

Notes on the application example

1. Contactors K3 and K4 have mirror contacts according to EN 60947-4-1.
2. Stop category 0 describes an immediate stop by removal of power by interrupting a machine or drive element according to EN 60204.
3. When using the safety relay, take into consideration the maximum permissible number of cycles for observing the SIL/PL safety characteristics in the specific application. The safety characteristics can be found in the FUNCTIONAL SAFETY CHARACTERISTICS data sheet or the SISTEMA library.

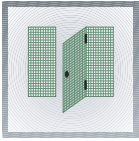

5.3.7 PSR-ESD/5x1/1x2/300 up to PL e/SIL 3

Two-channel safety door monitoring with delay contacts and manual reset (with cross-circuit detection)

Order No.	2981428 with screw connection 2981431 with spring-cage connection
Technical data	<ul style="list-style-type: none"> - 24 V DC - 3 undelayed enabling current paths, 2 delayed enabling current paths, 1 signaling current path - Adjustable delay time (0.2 ... 300 s) - Manual or automatic start - Reinforced insulation/basic insulation

Application example



- Two-channel safety door monitoring with two position switches
- Cross-circuit detection/ground fault detection (S11, S12 only)
- Manual reset (S33, S34)
- Feedback of contactor contacts K3 ... K6 at Y1 and Y2
- Release delay at K5 and K6
- Stop category 0/1
- Monitoring of external contactors
- Safety level of the example drive 1 PL e (EN ISO 13849-1) and SIL 3 (IEC 62061)
- Safety level of the example drive 2 PL d (EN ISO 13849-1) and SIL 2 (IEC 62061)

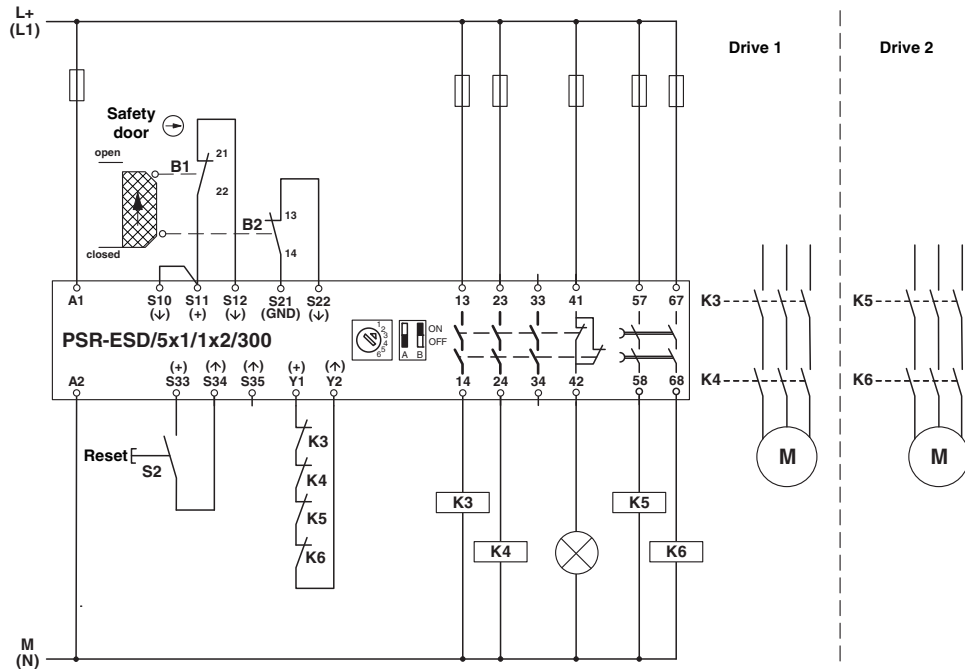
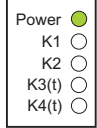
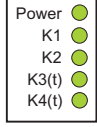
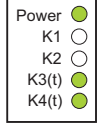
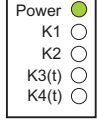

Figure 5-21 Two-channel safety door monitoring with delayed contacts and manual reset PSR-ESD/5x1/1x2/300

Function description

Start	Action	Result	Diagnostics
	1. Close the safety door.	The safety door circuit closes enable circuit S11, S12 and S21, S22 of the safety relay. Contactors K3 ... K6 are activated and the mirror contacts (N/C contacts of K3 ... K6) in the reset circuit are opened.	
	2. Press reset button S2.	Contactors K3 ... K6 are activated and the mirror contacts (N/C contacts of K3 ... K6) in the reset circuit (Y1, Y2) are opened.	
Stop	Action	Result	Diagnostics
	1. Open the safety door.	The safety function is triggered and contactors K3 and K4 are opened immediately.	
		After the preset time has elapsed, delay contacts 57, 58 and 67, 68 deactivate contactors K5 and K6 with a time delay. In the reset circuit, the mirror contacts of K3 ... K6 are closed.	

For additional diagnostic descriptions, please refer to Section 7.

Notes on the application example

1. The position switch is positive opening according to EN 60947-5-1.
2. Contactors K3, K4, K5, and K6 have mirror contacts according to EN 60947-4-1.
3. Stop category 0 describes an immediate stop by removal of power by interrupting a machine or drive element according to EN 60204.
4. Stop category 1 describes a controlled stop with power available according to EN 60204. This means that the power is only switched off after the connected machine has stopped.
5. When using the safety relay, take into consideration the maximum permissible number of cycles for observing the SIL/PL safety characteristics in the specific application. The safety characteristics can be found in the FUNCTIONAL SAFETY CHARACTERISTICS data sheet or the SISTEMA library.

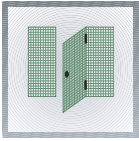

5.3.8 PSR-ESL4/3x1/1x2/B up to PL d/SIL 2

Two-channel non-equivalent safety door monitoring with manual reset

Order No.	2981059 with screw connection 2981062 with spring-cage connection
Technical data	<ul style="list-style-type: none"> - 24 V DC - 3 enabling current paths, 1 signaling current path - Monitored manual or automatic start - Basic insulation - Cat. 4/PL e according to EN ISO 13849-1, SIL CL 3 according to EN 62061

Application example

- Two-channel non-equivalent safety door monitoring with two position switches
- Manual reset (S33, S34)
- Feedback of contactor contacts K3 and K4 at S33 and S34
- Stop category 0
- Monitoring of external contactors
- Safety level of the example up to PL d (EN ISO 13849-1) and SIL 2 (EN 62061)

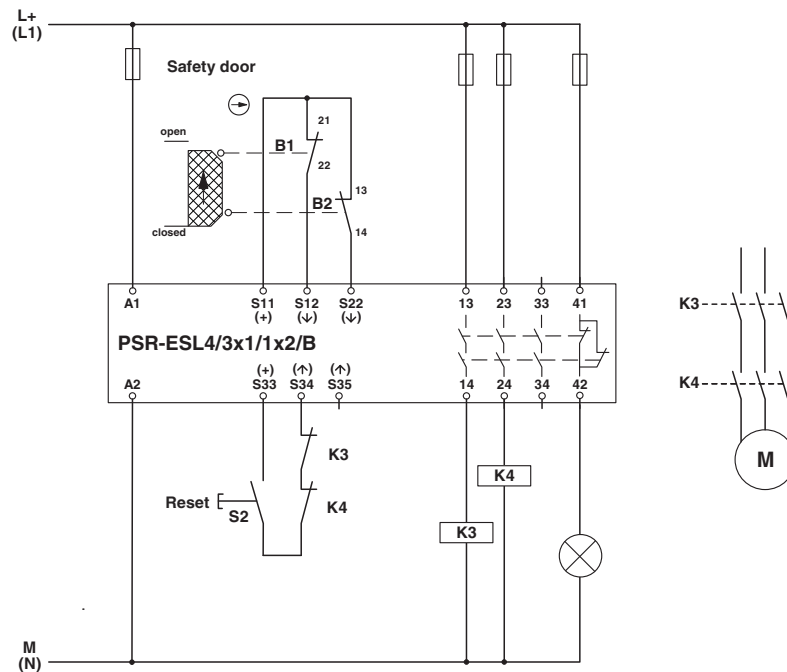
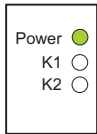



Figure 5-22 Two-channel safety door monitoring with manual reset PSR-ESL4/3x1/1x2/B

Function description

Start	Action	Result	Diagnostics
	1. Close the safety door.	The safety door circuit closes enable circuit S11, S12 and S11, S22 of the safety relay. The circuit is enabled via the reset button.	
	2. Press reset button S2.	Contactors K3 and K4 are activated and the mirror contacts (N/C contacts of K3 and K4) in the reset circuit are opened.	
Stop	Action	Result	Diagnostics
	1. Open the safety door.	The safety function is triggered and contactors K3 and K4 are opened. In the reset circuit, the mirror contacts of K3 and K4 are closed.	

For additional diagnostic descriptions, please refer to Section 7.

Notes on the application example

1. The connecting cables for the position switches in the sensor circuit (safety door switch) should either be laid separately or protected against mechanical damage.
2. The position switch is positive opening according to EN 60947-5-1.
3. Contactors K3 and K4 have mirror contacts according to EN 60947-4-1.
4. Stop category 0 describes an immediate stop by removal of power by interrupting a machine or drive element according to EN 60204.
5. When using the safety relay, take into consideration the maximum permissible number of cycles for observing the SIL/PL safety characteristics in the specific application. The safety characteristics can be found in the FUNCTIONAL SAFETY CHARACTERISTICS data sheet or the SISTEMA library.

5.4 Enable switch

An enable switch is an additional manually operated device that is used together with a startup control and permits machine operation while it is held down. Enable devices are frequently used together with emergency stop devices for the temporary suspension of safety functions. Simply pressing an enable switch must not start machine operation (see EN 60204-1). The hazardous movement should only be triggered by activating an additional control device.

Enable devices with the following properties should be selected:

- Designed according to ergonomic principles

a) For a type with two position settings:

- Position 1: off function of the switch (actuator is not operated)
- Position 2: enable function (actuator is operated)

b) For a type with three position settings:

- Position 1: off function of the switch (actuator is not operated)
- Position 2: enable function (actuator is operated and in its mid position)
- Position 3: off function (actuator is operated past its mid position)
- Returning from position 3 to position 2 does not activate the enable function



5.4.1 PSR-ESAM4/2x1/1x2 up to PL e/SIL 3

Three-stage enable switch monitoring with automatic reset
(cross-circuit detection)

Order No.	2900525 with screw connection 2900526 with spring-cage connection
Technical data	<ul style="list-style-type: none"> - 24 V AC/DC - 2 enabling current paths, 1 signaling current path - Manual or automatic start - Reinforced insulation - Cat. 4/PL e according to EN ISO 13849-1, SIL CL 3 according to EN 62061

Application example

- Three-stage enable switch monitoring
- Cross-circuit detection
- Ground fault detection (S11, S12 only)
- Automatic reset (S12, S35)
- Feedback of contactor contacts K3 and K4 at S35
- Stop category 0
- Monitoring of external contactors
- Safety level of the example up to PL e (EN ISO 13849-1) and SIL 3 (EN 62061)

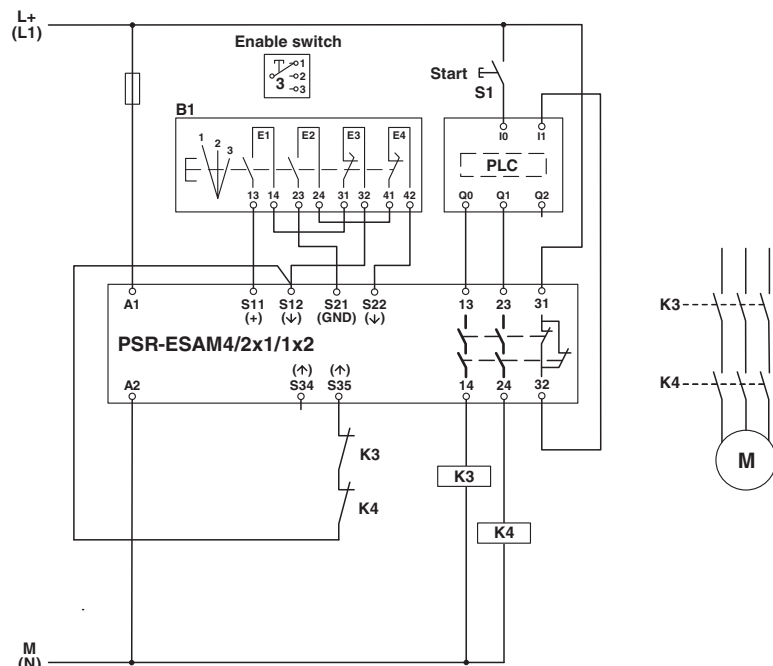
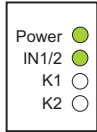
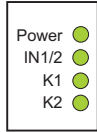
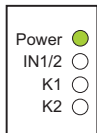

Figure 5-23 Three-stage enable switch monitoring with automatic reset
PSR-ESAM4/2x1/1x2

Function description

Start	Action	Result	Diagnostics
	1. Enable switch stage 1 (not activated)	The enable is expected via the enable switch.	
	2. Enable switch stage 2 (enable)	The enable switch closes enable circuit S11, S12 and S21, S22 of the safety relay. Contactors K3 and K4 are activated and the mirror contacts (N/C contacts of K3 and K4) in the reset circuit are opened.	
Stop	Action	Result	Diagnostics
	1. Enable switch stage 3 (pushed through)	<p>The safety function is triggered and contactors K3 and K4 are opened immediately.</p> <p>In the reset circuit, the mirror contacts of K3 and K4 are closed.</p>	

For additional diagnostic descriptions, please refer to Section 7.

Notes on the application example

1. When using enable switches, observe the notes in standards EN 60204 and EN ISO 10218.
2. Contactors K3 and K4 have mirror contacts according to EN 60947-4-1.
3. Stop category 0 describes an immediate stop by removal of power by interrupting a machine or drive element according to EN 60204.
4. A restart (after a stop from stage 3 of the enable switch) should only occur automatically if there is no hazardous situation.
5. When using the safety relay, take into consideration the maximum permissible number of cycles for observing the SIL/PL safety characteristics in the specific application. The safety characteristics can be found in the FUNCTIONAL SAFETY CHARACTERISTICS data sheet or the SISTEMA library.



5.4.2 PSR-ESAM4/3x1/1x2/B up to PL e/SIL 3

Two-stage enable switch monitoring with manual reset (cross-circuit detection)

Order No.	2900509 with screw connection 2900510 with spring-cage connection
Technical data	<ul style="list-style-type: none"> - 24 V AC/DC - 3 enabling current paths, 1 signaling current path - Manual or automatic start - Basic insulation - Cat. 4/PL e according to EN ISO 13849-1, SIL CL 3 according to EN 62061

Application example

- Two-stage enable switch monitoring
- Cross-circuit detection
- Ground fault detection (S11, S12 only)
- Manual reset (S12, S34)
- Feedback of contactor contacts K3 and K4 at S34
- Stop category 0
- Monitoring of external contactors
- Safety level of the example up to PL e (EN ISO 13849-1) and SIL 3 (EN 62061)

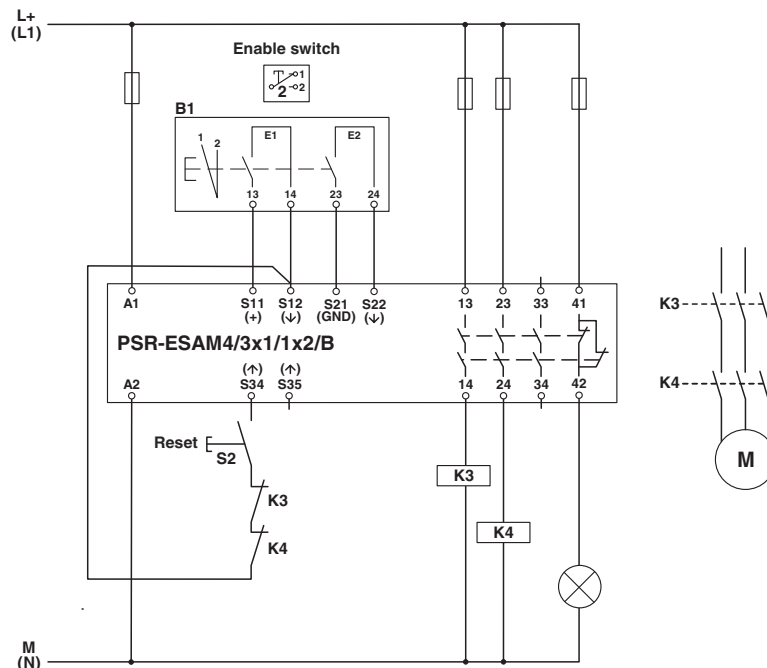
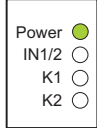

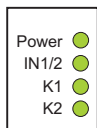
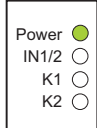

Figure 5-24 Two-stage enable switch monitoring with manual reset
PSR-ESAM4/3x1/1x2/B

Function description

Start	Action	Result	Diagnostics
	1. Enable switch stage 1 (not activated)	The enable is expected via the enable switch.	
	2. Enable switch stage 2 (enable)	The circuit is enabled via the reset button.	
	3. Press reset button S2	Contactors K3 and K4 are activated and the mirror contacts (N/C contacts of K3 and K4) in the reset circuit are opened.	
Stop	Action	Result	Diagnostics
	1. Enable switch stage 1 (not activated)	<p>The safety function is triggered and contactors K3 and K4 are opened immediately.</p> <p>In the reset circuit, the mirror contacts of K3 and K4 are closed.</p>	

For additional diagnostic descriptions, please refer to Section 7.

Notes on the application example

1. When using enable switches, observe the notes in standards EN 60204 and EN ISO 10218.
2. Contactors K3 and K4 have mirror contacts according to EN 60947-4-1.
3. Stop category 0 describes an immediate stop by removal of power by interrupting a machine or drive element according to EN 60204.
4. Depending on the level of risk, the use of a two-stage enable switch may only be permitted together with an emergency stop device.
5. When using the safety relay, take into consideration the maximum permissible number of cycles for observing the SIL/PL safety characteristics in the specific application. The safety characteristics can be found in the FUNCTIONAL SAFETY CHARACTERISTICS data sheet or the SISTEMA library.



5.4.3 PSR-ESAM4/2x1/1x2 up to PL e/SIL 3

Three-stage enable switch with two-channel emergency stop monitoring (cross-circuit detection)

Order No.	2900525 with screw connection 2900526 with spring-cage connection
Technical data	<ul style="list-style-type: none"> - 24 V AC/DC - 2 enabling current paths, 1 signaling current path - Manual or automatic start - Reinforced insulation - Cat. 4/PL e according to EN ISO 13849-1, SIL CL 3 according to EN 62061

Application example



- Three-stage enable switch monitoring
- Two-channel emergency stop monitoring
- Cross-circuit detection
- Ground fault detection (S11, S12 only)
- Manual reset (S12, S34) at safety relay KS1
- Automatic reset (S12, S35) at safety relay KS2
- Feedback of contactor contacts K5 and K6 at S35 at safety relay KS2
- Stop category 0
- Monitoring of external contactors
- Safety level of the example up to PL e (EN ISO 13849-1) and SIL 3 (EN 62061)

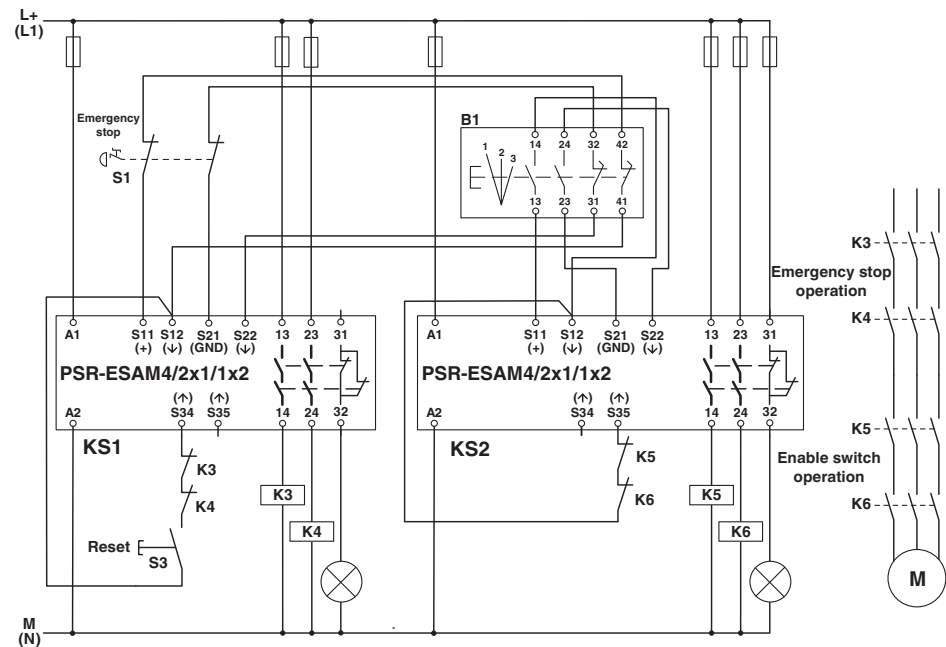

Figure 5-25 Three-stage enable switch with two-channel emergency stop monitoring PSR-ESAM4/2x1

Function description

Start	Action	Result	Diagnostics KS1	Diagnostics KS2
	1. Unlock emergency stop button S1.	The emergency stop circuit supplies the safety relay (KS1). The enable is expected via the reset button (S3).	Power ● IN1/2 ● K1 ○ K2 ○	Power ○ IN1/2 ○ K1 ○ K2 ○
	2. Press reset button S3.	Contactors K3 and K4 are activated and the mirror contacts (N/C contacts of K3 and K4) in the reset circuit are opened.	Power ● IN1/2 ● K1 ● K2 ●	Power ○ IN1/2 ○ K1 ○ K2 ○
Manual mode	1. Switch on switch S2.	The switch (S2) manual mode supplies the safety relay (KS2).	Power ● IN1/2 ● K1 ● K2 ●	Power ● IN1/2 ○ K1 ○ K2 ○
Enable function	1. Enable switch B1 stage 1 (not activated)	The enable is expected via the enable switch (B1).	Power ● IN1/2 ● K1 ● K2 ●	Power ● IN1/2 ○ K1 ○ K2 ○
	2. Enable switch B1 stage 2 (enable)	The enable switch (B1) closes sensor circuit S11, S12 and S21, S22 at the second safety relay (KS2). The automatic reset function closes enabling current paths 13, 14 and 23, 24 at the second safety relay (KS2). Holding down the enable switch (B1) keeps the safety function at the first safety relay (KS1) active.	Power ● IN1/2 ● K1 ● K2 ●	Power ● IN1/2 ● K1 ● K2 ●
Stop	Action	Result	Diagnostics KS1	Diagnostics KS2
	1. Enable switch stage 3 (pushed through)	The safety function is triggered and contactors K3 ... K6 are opened immediately. In the reset circuit, the mirror contacts (N/C contacts of K3 ... K6) of both safety relays KS1 and KS2 are closed.	Power ● IN1/2 ○ K1 ○ K2 ○	Power ● IN1/2 ○ K1 ○ K2 ○

For additional diagnostic descriptions, please refer to Section 7.

Notes on the application example

1. The emergency stop control device is positive opening according to EN 60947-5-1.
2. When using enable switches, observe the notes in standards EN 60204, EN ISO 10218, EN 1088, and EN ISO 13849-1.
3. Contactors K3, K4, K5, and K6 have mirror contacts according to EN 60947-4-1.
4. Stop category 0 describes an immediate stop by removal of power by interrupting a machine or drive element according to EN 60204.

5. When using the safety relay, take into consideration the maximum permissible number of cycles for observing the SIL/PL safety characteristics in the specific application. The safety characteristics can be found in the FUNCTIONAL SAFETY CHARACTERISTICS data sheet or the SISTEMA library.

5.5 Two-hand control device

According to EN 574, the simultaneity of two-hand control devices must be monitored to be < 0.5 seconds. The time is reliably checked and evaluated by corresponding category type III modules.

Two-hand control devices are localized safety equipment. The operator must keep his/her hands on the control device during dangerous machine movements.

Table 5-1 Requirements according to EN 574

Requirements according to EN 574	Type I	Type II	Type III		
			A	B	C
Use of both hands (simultaneous actuation)	X	X	X	X	X
Relationship between input signals and output signals (only both input signals -> output signal)	X	X	X	X	X
Prevention of accidental operation	X	X	X	X	X
Prevention of defeat	X	X	X	X	X
Re-initiation of an output signal (only once both input signals are finished -> re-initiation of the output signal is possible)		X	X	X	X
Synchronous actuation (simultaneous actuation within 0.5 seconds)			X	X	X
Safety category 1 application, EN 954-1	X		X		
Safety category 2 application, EN 954-1		X		X	
Safety category 3 application, EN 954-1					X

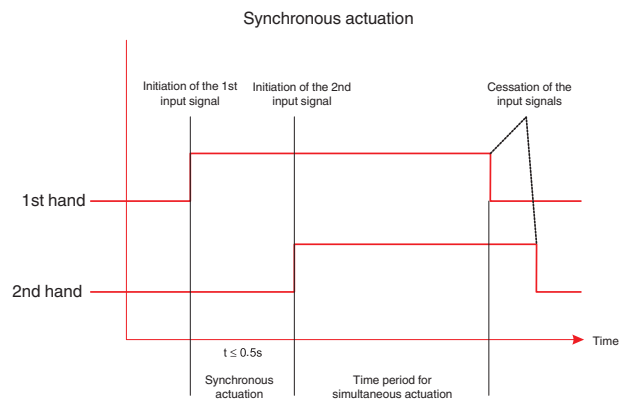
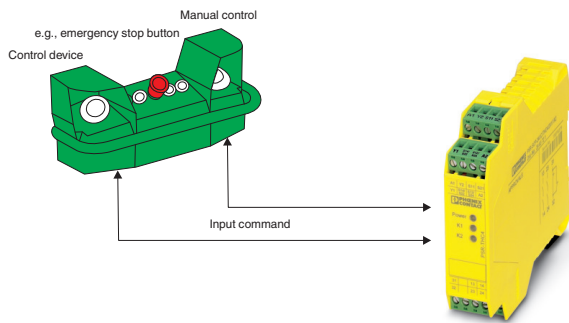
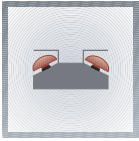

Figure 5-26 Structure of a two-hand control device



5.5.1 PSR-THC4/2x1/1x2 up to PL e/SIL 3

Two-hand control device monitoring

Order No.	2963721 with screw connection 2963983 with spring-cage connection
Technical data	<ul style="list-style-type: none"> - 24 V AC/DC - 2 enabling current paths, 1 signaling current path - Reinforced insulation - Two-hand and safety door control module according to EN 574 type IIIC - Cat. 4/PL e according to EN ISO 13849-1, SIL CL 3 according to EN 62061

Application example

- Two-hand control device monitoring
- Cross-circuit detection/ground fault detection
- Automatic reset (Y1, Y2)
- Feedback of contactor contacts K3 and K4 at Y1 and Y2
- Monitoring of external contactors
- Safety level of the example up to PL e (EN ISO 13849-1) and SIL 3 (EN 62061)

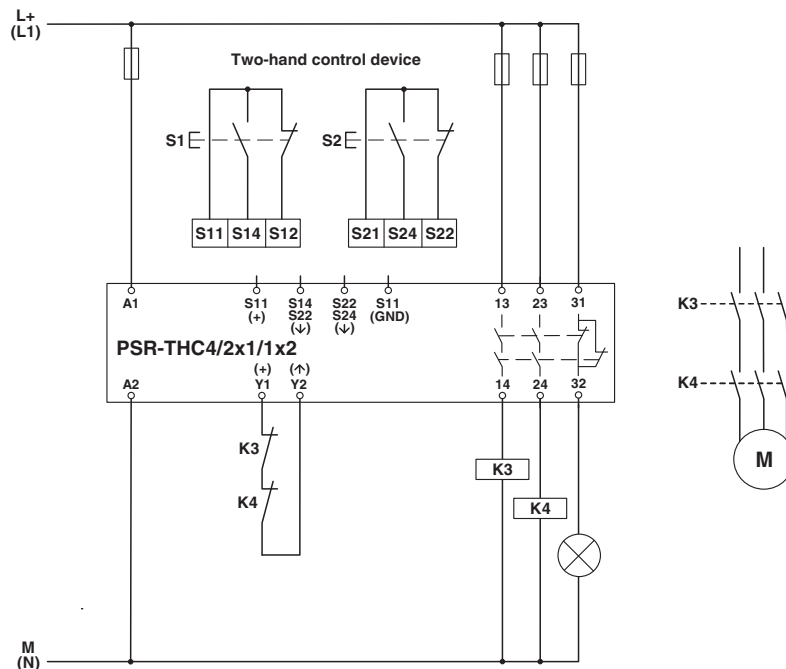

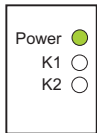

Figure 5-27 Two-hand control device monitoring PSR-THC4/2x1/1x2

Function description

Start	Action	Result	Diagnostics
	1. Both buttons on the two-hand control device are not pressed.	The enable is expected via both buttons.	
	2. Press both buttons on the two-hand control device simultaneously.	Contactors K3 and K4 are activated and the mirror contacts (N/C contacts of K3 and K4) are opened.	
Stop	Action	Result	Diagnostics
	1. Both buttons on the two-hand control device are not actuated.	The safety function is triggered and contactors K3 and K4 are opened. The mirror contacts of K3 and K4 are closed.	

For additional diagnostic descriptions, please refer to Section 7..

Notes on the application example

1. Two-hand operation according to EN 574 type IIIC.
2. Contactors K3 and K4 have mirror contacts according to EN 60947-4-1.
3. Stop category 0 describes an immediate stop by removal of power by interrupting a machine or drive element according to EN 60204.
4. When using the safety relay, take into consideration the maximum permissible number of cycles for observing the SIL/PL safety characteristics in the specific application. The safety characteristics can be found in the FUNCTIONAL SAFETY CHARACTERISTICS data sheet or the SISTEMA library.

5.6 Contact extension/forcibly guided contacts

Often more contacts are required than are available as standard. For these applications, the forcibly guided contact extension modules are used. They can be connected as modules as required.

Forced guidance

Standard EN 50205 makes a distinction between two groups of relays with forcibly guided contacts:

- Application type A: relay with forcibly guided set of contacts
- Application type B: relay with a forcibly guided set of contacts and other contacts which are not forcibly guided, as well as a contact set with PDTs

The definition of “forced guidance” according to EN 50205 is:

The relay must be designed so that none of the mechanically connected N/C contacts can close if a N/O contact is closed and none of the mechanically connected N/O contacts can close if a N/C contact is closed.

These requirements apply for the entire service life of the relay and for reasonably foreseeable failure conditions.

The effects of reasonably foreseeable breaks and/or wear on parts of the elementary relay must not cause the (mechanical) forced guidance to fail.

During the entire relay service life specified by the manufacturer, the contact distances of opened contacts must be greater than 0.5 mm for a single N/C contact and greater than 0.3 mm each for a double interrupt. (Mechanical) forced guidance of contacts means that none of the N/C contacts can close if a N/O contact does not open for the non-activated relay. In addition, none of the N/O contacts can close if a N/C contact does not open when the relay is activated.

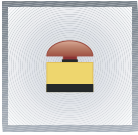

5.6.1 PSR-URM4/5x1/2x2 up to PL e/SIL 3

Two-channel emergency stop monitoring with contact extension and manual reset (with cross-circuit detection)

Order No.	2963734 with screw connection 2964005 with spring-cage connection
Technical data	<ul style="list-style-type: none"> - 24 V AC/DC - 5 enabling current paths, 1 signaling current path, and 1 alarm contact - Basic insulation - Cat. 4/PL e according to EN ISO 13849-1, SIL CL 3 according to EN 62061

Application example



- Two-channel emergency stop monitoring with contact extension
- Cross-circuit detection
- Ground fault detection (S11, S12 only)
- Manual reset (S12, S34) at safety relay KS1
- Feedback of contactor contacts K3 ... K8 and KS2 at S34 at safety relay KS1
- Stop category 0
- Monitoring of external contactors
- Safety level of the example up to PL e (EN ISO 13849-1) and SIL 3 (EN 62061)

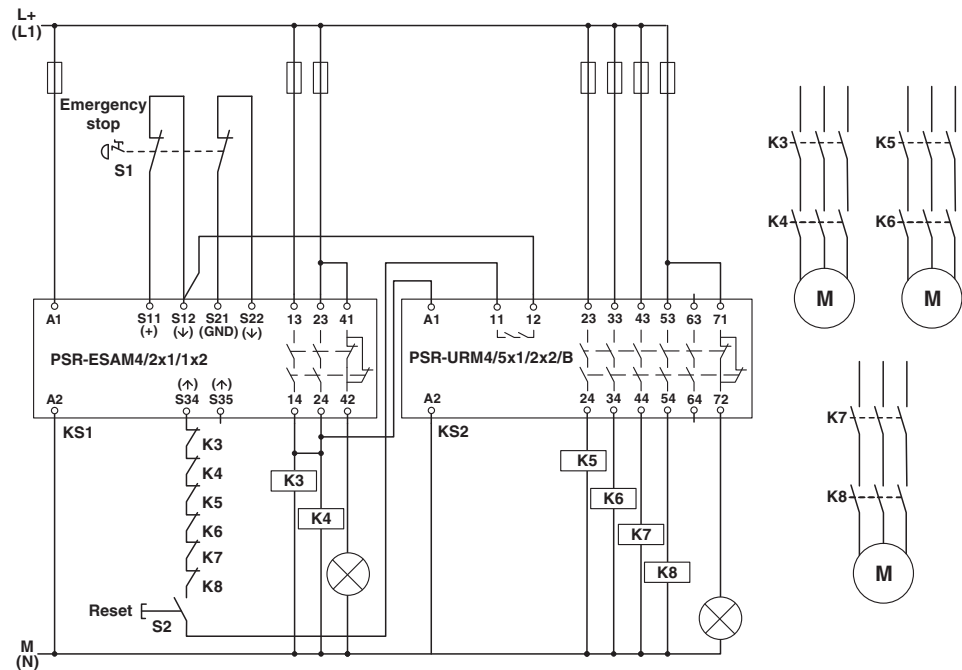

Figure 5-28 Application example: emergency stop monitoring with contact extension PSR-ESAM4/2x1/1x2 and PSR-URM4/5x1/2x2

Function description

Start	Action	Result	Diagnostics KS1	Diagnostics KS2
	1. Unlock emergency stop button S1.	The emergency stop button closes enable circuit S11, S12 and S21, S22 of the safety relay. The circuit is enabled via the reset button.		
2. Press reset button S2.	Contact extension KS2 and contactors K3 ... K8 are activated. The mirror contacts (N/C contacts of KS2 and K3 ... K8) in the reset circuit are opened.			
Stop	Action	Result	Diagnostics	Diagnostics
	1. Press emergency stop button S1.	The safety function is triggered and contact extension KS2 as well as contactors K3 ... K8 are opened. In the reset circuit, the N/C contacts of KS2 and K3 ... K8 are closed.		

For additional diagnostic descriptions, please refer to Section 7.

Notes on the application example

1. The emergency stop control device is positive opening according to EN 60947-5-1.
2. Contactors K3 to K8 have mirror contacts according to EN 60947-4-1.
3. Stop category 0 describes an immediate stop by removal of power by interrupting a machine or drive element according to EN 60204.
4. The system behavior for category 4 permits that if a single fault occurs, the safety function is always executed and the single fault is detected on or before the next demand of the safety function.
5. Install the safety relay with the contact extension in an installation space (e.g., in the control cabinet). This prevents a cross circuit at the output of the safety relay.
6. When using the safety relay, take into consideration the maximum permissible number of cycles for observing the SIL/PL safety characteristics in the specific application. The safety characteristics can be found in the FUNCTIONAL SAFETY CHARACTERISTICS data sheet or the SISTEMA library.

6 Application examples for modular safety relay system with PSR-TBUS connection

6.1 PSR-SDC4/2x1/B master module

Automatic mode selection

The intelligent master safety relay automatically identifies the desired operating mode via the sensor connections. This means that switches do not have to be set on the device.

The clearly arranged design of the modular safety relays helps you to quickly localize errors in your safety circuits.

Your advantages:

- Fast installation
- Error-free startup
- Easy error localization



Figure 6-1 PSR-SDC4/2x1/B master module

Safe cross-wiring with PSR-TBUS

PSR-TBUS DIN rail plug-in connectors help establish a rugged and safe connection between the master module and extension modules. This renders the usual cross-wiring for the supply voltage, the enable signal, and the confirmation current path redundant.

Fast system expansion

Up to ten safety relays can be easily connected to a PSR-TBUS DIN rail plug-in connector to create a safety system with 42 contacts.

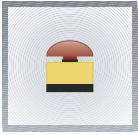

6.2 PSR-SDC4/2x1/B up to PL e/SIL 3

Two-channel emergency stop monitoring with manual reset
(with cross-circuit detection)

Order No.	2981486 with screw connection 2981499 with spring-cage connection
Technical data	<ul style="list-style-type: none"> - 24 V AC/DC - 2 enabling current paths, 1 semiconductor signaling current path - Monitored manual or automatic start - Basic insulation - Cat. 4/PL e according to EN ISO 13849-1, SIL CL 3 according to EN 62061

Application example

- Two-channel emergency stop monitoring
- Cross-circuit detection
- Ground fault detection (S11, S12 only)
- Manual reset (S33, S34)
- Feedback of contactor contacts K3 and K4 at S33 and S34
- Stop category 0
- Monitoring of external contactors
- Safety level of the example up to PL e (EN ISO 13849-1) and SIL 3 (EN 62061)

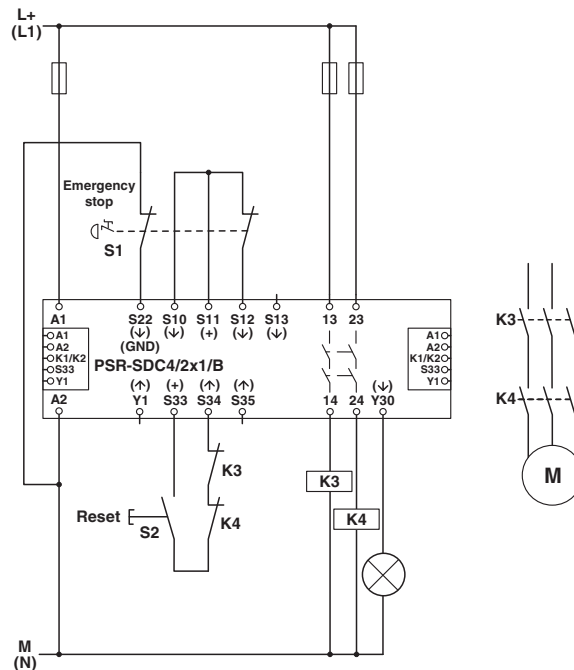
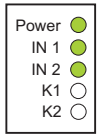
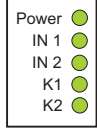
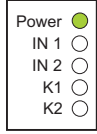

Figure 6-2 Two-channel emergency stop monitoring with manual reset PSR-SDC4/2x1/B

Application examples for modular safety relay system with PSR-TBUS connection

Function description

Start	Action	Result	Diagnostics
	1. Unlock emergency stop button S1.	The emergency stop button closes the first enable circuit via S10, S11, and S12 and the second enable circuit via A2 and S22 of the safety relay. The circuit is enabled via the reset button.	
	2. Press reset button S2.	Contactors K3 and K4 are activated and the mirror contacts (N/C contacts of K3 and K4) in the reset circuit are opened.	
Stop	Action	Result	Diagnostics
	1. Press emergency stop button S1.	The safety function is triggered and contactors K3 and K4 are opened. In the reset circuit, the mirror contacts of K3 and K4 are closed.	

For additional diagnostic descriptions, please refer to Section 7.

Notes on the application example

1. The emergency stop control device is positive opening according to EN 60947-5-1.
2. Contactors K3 and K4 have mirror contacts according to EN 60947-4-1.
3. When using the safety relay, take into consideration the maximum permissible number of cycles for observing the SIL/PL safety characteristics in the specific application. The safety characteristics can be found in the FUNCTIONAL SAFETY CHARACTERISTICS data sheet or the SISTEMA library.

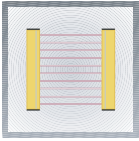

6.3 PSR-SDC4/2x1/B up to PL e/SIL 3

Two-channel light grid monitoring with manual reset (ESPE type 4)

Order No.	2981486 with screw connection 2981499 with spring-cage connection
Technical data	<ul style="list-style-type: none"> - 24 V AC/DC - 2 enabling current paths, 1 semiconductor signaling current path - Manual or automatic start - Basic insulation - Cat. 4/PL e according to EN ISO 13849-1, SIL CL 3 according to EN 62061

Application example

- Two-channel light grid monitoring
- Manual reset (S33, S34)
- Feedback of contactor contacts K3 and K4 at S33 and S34
- Stop category 0
- Monitoring of external contactors
- Safety level of the example up to PL e (EN ISO 13849-1) and SIL 3 (EN 62061)

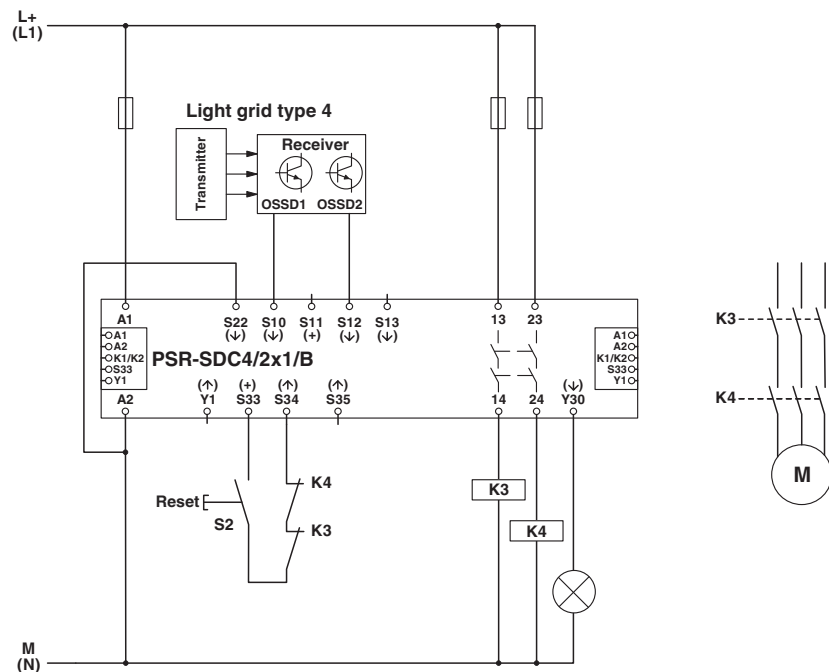
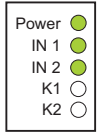
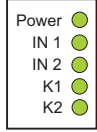
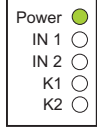

Figure 6-3 Two-channel light grid monitoring with manual reset PSR-SDC4/2x1/B

Application examples for modular safety relay system with PSR-TBUS connection

Function description

Start	Action	Result	Diagnostics
	1. The light grid is active, there is no object in the protected field.	Both OSSD signals from the light grid provide high signals to enable circuit S10-S12 of the safety relay.	
	2. Press reset button S2.	Contactors K3 and K4 are activated and the mirror contacts (N/C contacts of K3 and K4) in the reset circuit are opened.	
Stop	Action	Result	Diagnostics
	1. The light grid is interrupted, there is an object in the protected field.	The safety function is triggered by the interruption of the light grid and contactors K3 and K4 are opened. In the reset circuit, the mirror contacts of K3 and K4 are closed.	

For additional diagnostic descriptions, please refer to Section 7.

Notes on the application example

1. The light grid (ESPE) must meet type 4 requirements from standard EN 61496-1.
2. Contactors K3 and K4 have mirror contacts according to EN 60947-4-1.
3. Stop category 0 describes an immediate stop by removal of power by interrupting a machine or drive element according to EN 60204.
4. The system behavior for category 4 permits that if a single fault occurs, the safety function is always executed and the single fault is detected on or before the next demand of the safety function.
5. The advantage of category 4 compared to category 3 is that an accumulation of undetected faults does not lead to the loss of the safety function.
6. When using the safety relay, take into consideration the maximum permissible number of cycles for observing the SIL/PL safety characteristics in the specific application. The safety characteristics can be found in the FUNCTIONAL SAFETY CHARACTERISTICS data sheet or the SISTEMA library.

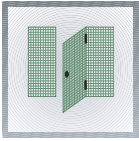

6.4 PSR-SDC4/2x1/B up to PL e/SIL 3

Two-channel non-equivalent safety door monitoring with manual reset

Order No.	2981486 with screw connection 2981499 with spring-cage connection
Technical data	<ul style="list-style-type: none"> - 24 V AC/DC - 2 enabling current paths, 1 semiconductor signaling current path - Monitored manual or automatic start - Basic insulation - Cat. 4/PL e according to EN ISO 13849-1, SIL CL 3 according to EN 62061

Application example

- Two-channel non-equivalent safety door monitoring with a magnetic safety switch
- Ground fault detection
- Manual reset (S33, S34)
- Feedback of contactor contacts K3 and K4 at S33 and S34
- Stop category 0
- Monitoring of external contactors
- Safety level of the example up to PL e (EN ISO 13849-1) and SIL 3 (EN 62061)

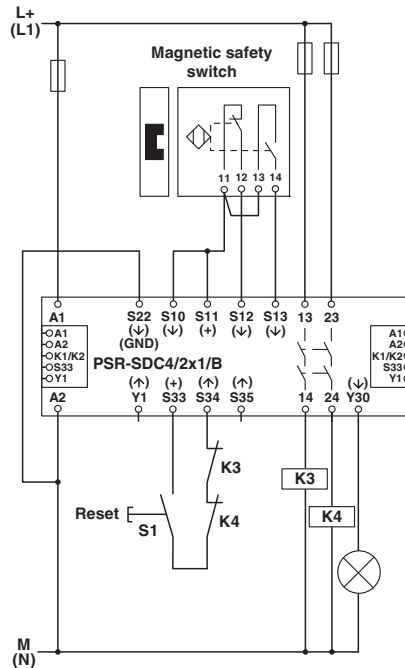
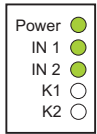
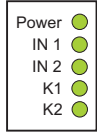
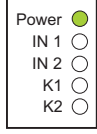

Figure 6-4 Two-channel safety door monitoring with manual reset PSR-SDC4/2x1/B

Application examples for modular safety relay system with PSR-TBUS connection

Function description

Start	Action	Result	Diagnostics
	1. Close the safety door.	The safety door circuit closes the first enable circuit via S10, S11, and S12 and opens the second enable circuit via S10, S11, and S13 of the safety relay. The circuit is enabled via the reset button.	
	2. Press reset button S1.	Contactors K3 and K4 are activated and the mirror contacts (N/C contacts of K3 and K4) in the reset circuit are opened.	
Stop	Action	Result	Diagnostics
	1. Open the safety door.	The safety function is triggered and contactors K3 and K4 are opened. In the reset circuit, the mirror contacts of K3 and K4 are closed.	

For additional diagnostic descriptions, please refer to Section 7.

Notes on the application example

1. The magnetic safety switch must meet the requirements of EN 60947-5-3.
2. Contactors K3 and K4 have mirror contacts according to EN 60947-4-1.
3. When using the safety relay, take into consideration the maximum permissible number of cycles for observing the SIL/PL safety characteristics in the specific application. The safety characteristics can be found in the FUNCTIONAL SAFETY CHARACTERISTICS data sheet or the SISTEMA library.

6.5 Contact extension/forcibly guided contacts

Often more contacts are required than are available as standard. For these applications, the forcibly guided contact extension modules are used. They can be connected as modules as required.

Forced guidance

Standard EN 50205 makes a distinction between two groups of relays with forcibly guided contacts:

- Application type A: relay with forcibly guided set of contacts
- Application type B: relay with a forcibly guided set of contacts and other contacts which are not forcibly guided, as well as a contact set with PDTs

The definition of “forced guidance” according to EN 50205 is:

The relay must be designed so that none of the mechanically connected N/C contacts can close if a N/O contact is closed and none of the mechanically connected N/O contacts can close if a N/C contact is closed.

These requirements apply for the entire service life of the relay and for reasonably foreseeable failure conditions.

The effects of reasonably foreseeable breaks and/or wear on parts of the elementary relay must not cause the (mechanical) forced guidance to fail.

During the entire relay service life specified by the manufacturer, the contact distances of opened contacts must be greater than 0.5 mm for a single N/C contact and greater than 0.3 mm each for a double interrupt. (Mechanical) forced guidance of contacts means that none of the N/C contacts can close if a N/O contact does not open for the non-activated relay. In addition, none of the N/O contacts can close if a N/C contact does not open when the relay is activated.

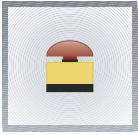

6.5.1 PSR-URM4/4x1/2x2/B up to PL e/SIL 3

Two-channel emergency stop monitoring with contact extension and manual reset (with cross-circuit detection)

Order No.	2981677 with screw connection 2981680 with spring-cage connection
Technical data	<ul style="list-style-type: none"> - 24 V AC/DC - 4 enabling current paths, 1 signaling current path, and 1 alarm contact - Basic insulation - Cat. 4/PL e according to EN ISO 13849-1, SIL CL 3 according to EN 62061

Application example

- Two-channel emergency stop monitoring with contact extension
- Cross-circuit detection
- Ground fault detection (S11, S12 only)
- Manual reset (S33, S34)
- Feedback of contactor contacts K3 ... K6 at S33 and S34
- Stop category 0
- Monitoring of external contactors
- Safety level of the example up to PL e (EN ISO 13849-1) and SIL 3 (EN 62061)

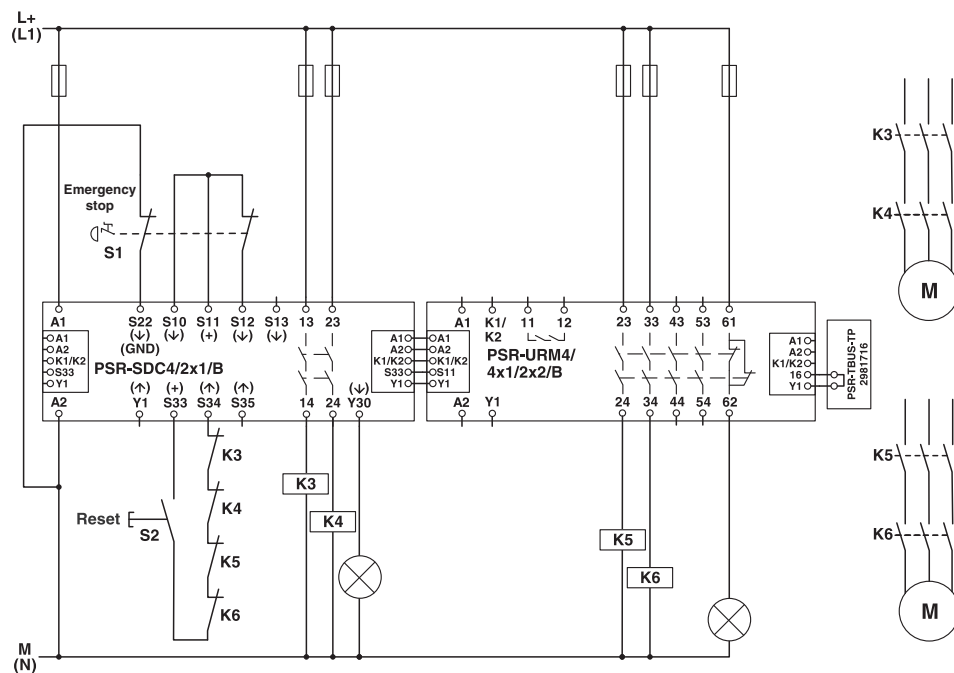

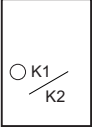

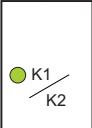
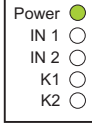



Figure 6-5 Two-channel emergency stop monitoring with contact extension and manual reset PSR-SDC4/2x1/B and PSR-URM4/4x1/2x2/B

Application examples for modular safety relay system with PSR-TBUS connection

Function description

Start	Action	Result	Diagnostics	Diagnostics
	1. Unlock emergency stop button S1.	The emergency stop button closes the first enable circuit via S10, S11, and S12 and closes the second enable circuit via A2 and S22 of the safety relay.		
	2. Press reset button S2.	Contactors K3 ... K6 are activated and the mirror contacts (N/C contacts of K3 ... K6) in the reset circuit are opened.		
Stop	Action	Result	Diagnostics	Diagnostics
	1. Press emergency stop button S1.	The safety function is triggered and contactors K3 ... K6 are opened. In the reset circuit, the mirror contacts of K3 ... K6 are closed.		

For additional diagnostic descriptions, please refer to Section 7.

Notes on the application example

1. The emergency stop control device is positive opening according to EN 60947-5-1.
2. Contactors K3, K4, K5, and K6 have mirror contacts according to EN 60947-4-1.
3. Stop category 0 describes an immediate stop by removal of power by interrupting a machine or drive element according to EN 60204.
4. When using the safety relay, take into consideration the maximum permissible number of cycles for observing the SIL/PL safety characteristics in the specific application. The safety characteristics can be found in the FUNCTIONAL SAFETY CHARACTERISTICS data sheet or the SISTEMA library.
5. The (holding) brake is not part of the safety function.

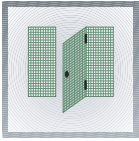

6.5.2 PSR-URD3/4x1/2x2/3 up to PL d/SIL 2

Two-channel safety door monitoring with delay contact extension and automatic reset

Order No.	2981732 with screw connection 2981745 with spring-cage connection
Technical data	<ul style="list-style-type: none"> - 24 V DC - 4 delayed enabling current paths, 1 signaling current path, and 1 alarm contact - Basic insulation - Cat. 4/PL e according to EN ISO 13849-1, SIL CL 3 according to EN 62061

Application example



- Two-channel safety door monitoring with delay contact extension
- Ground fault detection
- Automatic reset (S33, S35, Y1)
- Feedback of contactor contacts K3 and K4 at S35 and Y1
- Stop category 0
- Stop category 1
- Monitoring of external contactors
- Safety level of the example up to PL d (EN ISO 13849-1) and SIL 2 (EN 62061)

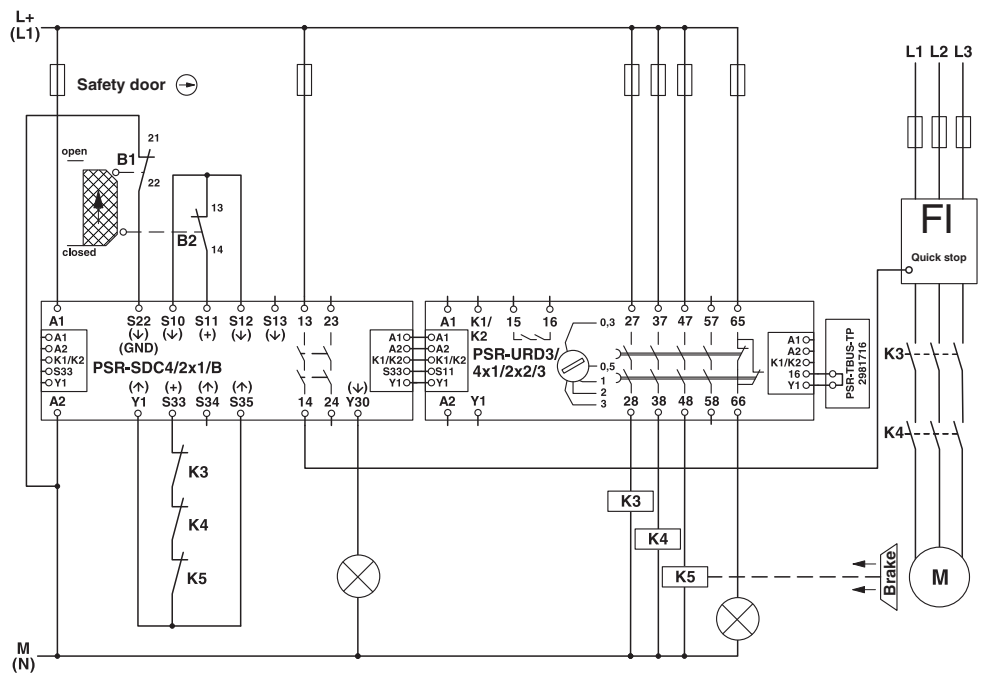

Figure 6-6 Application example: safety door with delay contact extension PSR-SDC4/2x1/B and PSR-URD3/4x1/2x2/3

Application examples for modular safety relay system with PSR-TBUS connection

Function description

Start	Action	Result	Diagnostics	Diagnostics
	1. Close the safety door.	<p>The safety door circuit closes the first enable circuit via S10 and S11 and closes the second enable circuit via S11 and S12 of the safety relay.</p> <p>Contactors K3 and K4 are activated and the mirror contacts (N/C contacts of K3 and K4) in the reset circuit are opened.</p>		
Stop	2. Open the safety door.	<p>The safety function is triggered and contactors K3 and K4 are opened after a preset time.</p> <p>In the reset circuit, the mirror contacts of K3 and K4 are closed after a preset time.</p>		
		<p>After the preset time has elapsed, the delayed enable contacts of the safety relay are opened.</p>		



For additional diagnostic descriptions, please refer to Section 7.

Notes on the application example

1. The connecting cables for the position switches in the sensor circuit (safety door switch) should either be laid separately or protected against mechanical damage.
2. The position switch is positive opening according to EN 60947-5-1.
3. Contactors K3 and K4 have mirror contacts according to EN 60947-4-1.
4. Stop category 0 describes an immediate stop by removal of power by interrupting a machine or drive element according to EN 60204.
5. Stop category 1 describes a controlled stop with power available according to EN 60204. This means that the power is only switched off after the connected machine has stopped.
6. The system behavior for category 3 permits that if a fault occurs, e.g., the failure of a switching element in the emergency stop circuit, the safety function is still maintained. However, the requirement that a single fault must be detected does not mean that all faults are detected. An accumulation of undetected faults can lead to the loss of the safety function.
7. Install the safety relay and contactors together in an installation space according to EN 60204 (e.g., in the control cabinet). This prevents a cross circuit at the output of the safety relay.
8. When using the safety relay, take into consideration the maximum permissible number of cycles for observing the SIL/PL safety characteristics in the specific application. The safety characteristics can be found in the FUNCTIONAL SAFETY CHARACTERISTICS data sheet or the SISTEMA library.

7 Diagnostic description















Meaning of the LED symbols in the tables below:

LED OFF	
LED ON	
LED flashing	

The table is valid for the following safety relays:

- 1 PSR-ESL4/3x1/1x2/B
- 2 PSR-ESA2/4x1/1x2/B
- 3 PSR-ESAM2/3x1/1x2/B
- 4 PSR-ESAM4/3x1/1x2
- 5 PSR-ESAM4/8x1/1x2
- 6 PSR-THC4/2x1/1x2

Table 7-1 Diagnostic description for PSR-ESL4/..., PSR-ESA2/..., PSR-ESAM2/..., PSR-ESAM4/..., and PSR-THC4/... safety relays

	PWR	K1	K2			Error	Remedy	Valid for
Connection/ voltage error						Supply voltage not present.	Apply supply voltage	All
						Supply voltage too low.	Adjust supply voltage	All
								
						The enable circuits are connected incorrectly or not connected at all.	Check the connection of the enable circuits	All
						No bridge between Y1 and Y2.	Insert bridge	6

Application manual for PSR safety relays

Table 7-1 Diagnostic description for PSR-ESL4/..., PSR-ESA2/..., PSR-ESAM2/..., PSR-ESAM4/..., and PSR-THC4/... safety relays

	PWR	K1	K2		Error	Remedy	Valid for
Cross circuit					Between both enable circuits S11-S12 and S11-S22. Error detection on next demand. E.g., for emergency stop or safety door.	Remove cross circuit	1
					Between both enable circuits S11-S22 and S11-S12. Error detection on next demand. E.g., for emergency stop or safety door.		1
					Between enable circuit S11-S12 and S21-S22.		4, 5
					Between both enable circuits S12 and S22. The error is not detected by the module itself. E.g., for light grid type 4.		1
Cross circuit					Between enable circuit S11-S14/S12 and S21-S24/S22.	Remove cross circuit	6
Short circuit					Short circuit between contact points A1 and A2.	Remove short circuit	All
					Between S11 and S12. Error detection on next demand.		1, 4, 5
					Between S11 and S22. Error detection on next demand.		1, 4, 5
					Between S11 and S12 or S11 and S14. Error detection on next demand.		6
					Between S21 and S22 or S21 and S24. Error detection on next demand.		6
Error in reset circuit					Faulty reset button, short circuit between S33 and S34. No error detection on initial start, only on first new demand.	Remove short circuit	1, 2, 3, 4, 5
Error with internal cause					Enable contact(s) of K1 faulty.	Replace the safety relay.	All
					Enable contact(s) of K2 faulty.		
					Enable contact(s) of K1 and K2 faulty.		

The table is valid for the following safety relays:













- 1 PSR-ESAM4/2x1/1x2
- 2 PSR-ESAM4/3x1/1x2/B
- 3 PSR-ESA4/2x1/1x2
- 4 PSR-ESA4/3x1/1x2/B
- 5 PSR-ESM4/3x1/1x2/B

Table 7-2 Diagnostic description for PSR-ESAM4/... and PSR-ESA4/... safety relays

	PWR	IN1/2	K1	K2	Error	Remedy	Valid for
Connection/ voltage error	●	●	●	●	Supply voltage not present.	Apply supply voltage	All
	☀	☀	☀	●	Supply voltage too low.	Adjust supply voltage	1
	☀	☀	●	●			2
	☀	☀	●	☀			3, 4, 5
	☀	●	●	●	The enable circuits are connected incorrectly or not connected at all.	Check the connection of the enable circuits	1
Cross circuit	●	●	●	●	Between both enable circuits S11-S12 and S21-S22. E.g., for emergency stop.	Remove cross circuit	All
Short circuit	●	●	●	●	Short circuit between contact points A1 and A2.	Remove short circuit	All
	☀	☀	☀	●	Between S11 and S12. Error detection on next demand.		All
	☀	☀	●	☀	Between S21 and S22. Error detection on next demand.		All
Error in reset circuit	☀	☀	●	☀	Faulty reset button, short circuit between S12 and S34.	Replace reset button Remove short circuit	1
	☀	☀	●	●	No error detection on initial start, only on first new demand.	Replace reset button Remove short circuit	2
	☀	☀	●	☀	Faulty reset button, short circuit between S33 and S34. No error detection on initial start, only on first new demand.	Replace reset button Remove short circuit	5

Application manual for PSR safety relays

Table 7-2 Diagnostic description for PSR-ESAM4/... and PSR-ESA4/... safety relays

	PWR	IN1/2	K1	K2	Error	Remedy	Valid for
Error in reset circuit					Enable contact(s) of K1 faulty.	Replace the safety relay.	All
					Enable contact(s) of K2 faulty.		
					Enable contact(s) of K1 and K2 faulty.		

The table is valid for the following safety relays:

- 1 PSR-ESD/5x1/1x2/300
- 2 PSR-ESD/5x1/1x2/T

Table 7-3 Diagnostic description for PSR-ESD/5x1/1x2/... safety relays

	PWR	K1	K2	K3(t)	K4(t)	Error	Remedy	Valid for
Connection/ voltage error	●	●	●	●	●	Supply voltage not present.	Apply supply voltage	All
	☀	●	●	●	●	Supply voltage too low.	Adjust supply voltage	
	☀	●	●	●	●	The enable circuits are connected incorrectly or not connected at all.	Check the connection of the enable circuits	
	☀	●	●	●	●	No bridge between Y1 and Y2.	Insert bridge	
	☀	●	●	●	●	No bridge between S10 and S11. E.g., for two-channel emergency stop wiring.	Insert bridge	
Cross circuit	●	●	●	●	●	Between both enable circuits S10/S11-S12 and S21-S22. E.g., for emergency stop or safety door.	Remove cross circuit	
	☀	●	●	●	●	Between both enable circuits S10 and S12. E.g., for light grid type 4.		
Short circuit	●	●	●	●	●	Short circuit between contact points A1 and A2.	Remove short circuit	
	☀	☀	●	●	●	Between S11 and S12. Error detection on next demand.		
	☀	●	☀	●	●	Between S21 and S22. Error detection on next demand.		
Error in reset circuit	☀	●	☀	●	●	Faulty reset button, short circuit between S33 and S34. No error detection on initial start, only on first new demand.	Remove short circuit	
Error with internal cause	☀	●	☀	☀	☀	Enable contact(s) of K1 faulty.	Replace the safety relay.	All























The table is valid for the following safety relays:

1 PSR-ESD/4x1/30

Table 7-4 Diagnostic description for PSR-ESD/4x1/30 safety relay

	PWR	K1/K2	K3(t)/K4(t)			Error	Remedy
Connection/ voltage error	●	●	●			Supply voltage not present.	Apply supply voltage
	☀	●	●			Supply voltage too low.	Adjust supply voltage
	☀/● 1 s	●	●			Supply voltage too high.	Adjust supply voltage
	☀	●	●			The enable circuits are connected incorrectly or not connected at all.	Check the connection of the enable circuits
Cross circuit	☀/● 1 s	●	●			Between both enable circuits S11-S12 and S21-S22. E.g., for emergency stop or safety door.	Remove cross circuit
	☀/● 1 s	●	●			Between both enable circuits S12 and S22. E.g., for light grid type 4.	
Short circuit	●	●	●			Short circuit between contact points A1 and A2.	Remove short circuit
	☀/● 1 s	●	●			Between S11 and S12. Error detection on next demand.	
	☀/● 1 s	●	●			Between S21 and S22. Error detection on next demand.	
Error in reset circuit	☀/● 1 s	●	●			Short circuit between A1 and S34 (e.g., faulty reset button). No error detection on initial start, only once all enable contacts have been opened.	Remove short circuit

Table 7-4 Diagnostic description for PSR-ESD/4x1/30 safety relay

	PWR	K1/K2	K3(t)/K4(t)			Error	Remedy
Configuration error	 /  1 s	 /  1 s				If a cross circuit or surge voltage/undervoltage occurs during the configuration phase, the safety module indicates a configuration error.	Check the wiring and the operating voltage supply. Perform a voltage reset.
	 /  1 s	 /  1 s	 /  1 s			Rotary switch (delay time) was modified during operation.	Carry out configuration again.
Error with internal cause	 /  0.2 s					Safety relay faulty.	Replace the safety relay. Perform a voltage reset.
	 /  0.2 s					Enable contact(s) of K1 and K2 faulty.	
	 /  0.2 s					Enable contact(s) of K3 and K4 faulty.	

The table is valid for the following safety relays:

- 1 PSR-URM4/5x1/2x2

Table 7-5 Diagnostic description for PSR-URM4/5x1/2x2 safety relay

	K1	K2				Error	Remedy
Connection/ voltage error	●	●				Supply voltage not present.	Apply supply voltage
	●	●				Supply voltage too low.	Adjust supply voltage
	●	☀				Input circuit A11 is not being supplied with power.	Check the input circuit connection
	☀	●				Input circuit A12 is not being supplied with power.	
Short circuit	●	●				Short circuit between contact points A11 and A2 or between A12 and A2.	Remove short circuit
Error with internal cause	●	●				Confirmation contacts 11 and 12 are faulty.	Replace the safety relay. Perform a voltage reset.
	●	☀				Enable contact(s) of K1 faulty.	
	☀	●				Enable contact(s) of K2 faulty.	
	●	●				Enable contact(s) of K1 and K2 faulty.	

The table is valid for the following safety relays:

- 1 PSR-URM4/5x1/2x2/B

Table 7-6 Diagnostic description for PSR-URM4/5x1/2x2/B safety relay

Connection/ voltage error	●					Supply voltage not present.	Apply supply voltage
	●					Supply voltage too low.	Adjust supply voltage
	●					The input circuit is connected incorrectly or not connected at all.	Check the input circuit connection
Short circuit	●					Short circuit between contact points A1 and A2.	Remove short circuit
Error with internal cause	●					Confirmation contacts 11 and 12 are faulty.	Replace the safety relay. Perform a voltage reset.
	●					Enable contact(s) of K1 and K2 faulty.	

The table is valid for the following safety relays:

1 PSR-SDC4/2x1/B

Table 7-7 Diagnostic description for PSR-SDC4/2x1/B safety relay

	PWR	IN1	IN2	K1	K2	Error	Remedy
Connection/ voltage error	●	●	●	●	●	Supply voltage not present.	Apply supply voltage
	●	●	●	●	●	Supply voltage too low.	Adjust supply voltage
	☀	☀	☀	●	☀		
	☀	●	●	●	●	The enable circuits are connected incorrectly or not connected at all.	Check the connection of the enable circuits
Cross circuit	●	●	●	●	●	Between both enable circuits S11/S12-S10 and A2-S22. E.g., for emergency stop.	Remove cross circuit
	☀	●	●	●	●	Between both enable circuits S12 and S10. The error is not detected by the module itself. E.g., for light grid type 4.	
Short circuit	●	●	●	●	●	Short circuit between contact points A1 and A2.	Remove short circuit
	☀	☀	☀	☀	●	Between S11 and S12 or S10 and S12. Error detection on next demand.	
	☀	☀	●	☀	●	Between S11 and S13. The error is detected immediately.	
	☀	☀	●	☀	●	Between S10 and S12. The error is detected immediately.	
	☀	☀	☀	●	☀	Between A2 and S22. Error detection on next demand.	
Error in reset circuit	☀	☀	☀	●	☀	Faulty reset button, short circuit between S33 and S34. No error detection on initial start, only on first new demand.	Replace reset button Remove short circuit
	☀	☀	☀	●	☀	Enable contact(s) of K1 faulty.	Replace the safety relay.
	☀	☀	☀	☀	●	Enable contact(s) of K2 faulty.	
	☀	☀	☀	●	●	Enable contact(s) of K1 and K2 faulty.	

The table is valid for the following safety relays:

- 1 PSR-URM4/4x1/2x2/B

Table 7-8 Diagnostic description for PSR-URM4/4x1/2x2/B safety relay

	K1/K2					Error	Remedy
Connection/ voltage error	●					Supply voltage not present.	Apply supply voltage, e.g., via the PSR-T-BUS DIN rail connector.
	●					Supply voltage too low.	Adjust supply voltage
	●					The input circuit is connected incorrectly or not connected at all.	Check the PSR-T-BUS connections between the modules. Insert PSR-T-BUS-TP dummy plug.
Short circuit	●					Short circuit between contact points A1 and A2.	Remove short circuit
Error with internal cause	●					Confirmation contacts 11 and 12 are faulty.	Replace the safety relay.
	●					Enable contact(s) of K1 and K2 faulty.	

The table is valid for the following safety relays:

- 1 PSR-URD3/4x1/2x1/3
- 2 PSR-URD3/4x1/2x2
- 3 PSR-URD3/4x1/2x2/T2

Table 7-9 Diagnostic description for PSR-URD3/4x1/... safety relays

Connection/ voltage error	●	●	●			Supply voltage not present.	Apply supply voltage, e.g., via the PSR-T-BUS DIN rail connector.
	☀	●	●			Supply voltage too low.	Adjust supply voltage
	●	●	●			The input circuit is connected incorrectly or not connected at all.	Check the PSR-T-BUS connections between the modules. Insert PSR-T-BUS-TP dummy plug.

Application manual for PSR safety relays

Table 7-9 Diagnostic description for PSR-URD3/4x1/... safety relays

Short circuit	●	●	●			Short circuit between contact points A1 and A2.	Remove short circuit
Error with internal cause	☀	●	●			Confirmation contacts 15 and 16 are faulty.	Replace the safety relay.
	☀	●	☀			Enable contact of K1(t) is faulty.	
	☀	☀	●			Enable contact of K2(t) is faulty.	

A Appendix for document lists

A 1 List of figures

Section 2

Figure 2-1:	Risk reduction in machines	2-1
Figure 2-2:	Risk graph (according to EN 13849-1)	2-3
Figure 2-3:	Safety-related block diagram (according to EN 13849-1)	2-4
Figure 2-4:	Relationship between PL, category, DC, and MTTFd (according to EN 13849-1)	2-4
Figure 2-5:	Example of specifying the SIL (according to EN 62061)	2-7
Figure 2-6:	Logical representation of subsystem A (according to EN 62061)	2-8
Figure 2-7:	Logical representation of subsystem B (according to EN 62061)	2-8
Figure 2-8:	Logical representation of subsystem C (according to EN 62061)	2-9
Figure 2-9:	Logical representation of subsystem D (according to EN 62061)	2-9

Section 3

Figure 3-1:	Cross-circuit detection	3-1
Figure 3-2:	Cable lengths	3-2
Figure 3-3:	Example, stop category 0	3-4
Figure 3-4:	Example, stop category 1	3-4
Figure 3-5:	Example, stop category 2	3-5

Section 5

Figure 5-1:	Emergency stop	5-1
Figure 5-2:	Single-channel emergency stop monitoring with manual reset PSR-ESM4/2x1/1x2	5-2
Figure 5-3:	Single-channel emergency stop monitoring with manual reset PSR-ESL4/3x1/1x2/B	5-4
Figure 5-4:	Single-channel emergency stop monitoring with manual reset PSR-ESD/4x1/30	5-6
Figure 5-5:	Two-channel emergency stop monitoring with manual reset PSR-ESAM4/2x1/1x2	5-8
Figure 5-6:	Two-channel emergency stop monitoring with manual reset PSR-ESM4/3x1/1x2B	5-10
Figure 5-7:	Two-channel emergency stop monitoring with manual reset PSR-ESL4/3x1/1x2/B	5-12

Figure 5-8:	Two-channel emergency stop monitoring with manual reset PSR-ESAM4/8x1/1x2	5-14
Figure 5-9:	Two-channel emergency stop monitoring with delayed contacts PSR-ESD/4x1/30	5-16
Figure 5-10:	Two-channel cable-operated switch monitoring with manual reset PSR-ESAM4/3x1/1x2/B	5-18
Figure 5-11:	Two-channel light grid monitoring with manual reset PSR-ESL4/3x1/1x2/B	5-22
Figure 5-12:	Two-channel light grid monitoring with manual reset PSR-ESD/4x1/30	5-24
Figure 5-13:	Two-channel light grid monitoring with automatic reset PSR-ESAM4/8x1/1x2	5-26
Figure 5-14:	Two-channel laser scanner monitoring with manual reset PSR-ESD/4x1/30	5-28
Figure 5-15:	Two-channel safety door monitoring with automatic reset PSR-ESA4/2x1/1x2	5-32
Figure 5-16:	Two-channel safety door monitoring with manual reset PSR-ESAM4/2x1	5-34
Figure 5-17:	Two-channel safety door monitoring with manual reset PSR-ESAM4/3x1	5-36
Figure 5-18:	Two-channel safety door monitoring with manual reset PSR-ESAM4/3x1B	5-38
Figure 5-19:	Two-channel safety door monitoring with delayed contacts and automatic reset PSR-ESD/4x1/30	5-40
Figure 5-20:	Two-channel safety door monitoring with delayed contacts and manual reset PSR-ESD/4x1/30	5-42
Figure 5-21:	Two-channel safety door monitoring with delayed contacts and manual reset PSR-ESD/5x1/1x2/300	5-44
Figure 5-22:	Two-channel safety door monitoring with manual reset PSR-ESL4/3x1/1x2/B	5-46
Figure 5-23:	Three-stage enable switch monitoring with automatic reset PSR-ESAM4/2x1/1x2	5-50
Figure 5-24:	Two-stage enable switch monitoring with manual reset PSR-ESAM4/3x1/1x2/B	5-52
Figure 5-25:	Three-stage enable switch with two-channel emergency stop monitoring PSR-ESAM4/2x1	5-54
Figure 5-26:	Structure of a two-hand control device	5-57
Figure 5-27:	Two-hand control device monitoring PSR-THC4/2x1/1x2	5-58
Figure 5-28:	Application example: emergency stop monitoring with contact extension PSR-ESAM4/2x1/1x2 and PSR-URM4/5x1/2x2	5-62

Section 6

Figure 6-1:	PSR-SDC4/2x1/B master module	6-1
Figure 6-2:	Two-channel emergency stop monitoring with manual reset PSR-SDC4/2x1/B	6-2
Figure 6-3:	Two-channel light grid monitoring with manual reset PSR-SDC4/2x1/B	6-4
Figure 6-4:	Two-channel safety door monitoring with manual reset PSR-SDC4/2x1/B	6-6
Figure 6-5:	Two-channel emergency stop monitoring with contact extension and manual reset PSR-SDC4/2x1/B and PSR-URM4/4x1/2x2/B	6-10
Figure 6-6:	Application example: safety door with delay contact extension PSR-SDC4/2x1/B and PSR-URD3/4x1/2x2/3	6-12

A 2 List of tables

Section 2

Table 2-1:	Explanation of categories	2-5
Table 2-2:	Determination of the safety integrity level (according to EN 62061)	2-10
Table 2-3:	Determination of the safety integrity level for a subsystem with discrete components (according to EN 62061)	2-10

Section 4

Table 4-1:	Overview of PSR safety relays	4-1
Table 4-2:	Overview of PSR-SDC4 modular safety relay system	4-3

Section 5

Table 5-1:	Requirements according to EN 574	5-57
------------	--	------

Section 7

Table 7-1:	Diagnostic description for PSR-ESL4/..., PSR-ESA2/..., PSR-ESAM2/..., PSR-ESAM4/..., and PSR-THC4/... safety relays	7-1
Table 7-2:	Diagnostic description for PSR-ESAM4/... and PSR-ESA4/... safety relays	7-3
Table 7-3:	Diagnostic description for PSR-ESD/5x1/1x2/... safety relays	7-5
Table 7-4:	Diagnostic description for PSR-ESD/4x1/30 safety relay	7-6
Table 7-5:	Diagnostic description for PSR-URM4/5x1/2x2 safety relay	7-8
Table 7-6:	Diagnostic description for PSR-URM4/5x1/2x2/B safety relay	7-9
Table 7-7:	Diagnostic description for PSR-SDC4/2x1/B safety relay	7-10
Table 7-8:	Diagnostic description for PSR-URM4/4x1/2x2/B safety relay	7-11
Table 7-9:	Diagnostic description for PSR-URD3/4x1/... safety relays	7-11

A 3 Explanation of terms

Performance level (PL)	Classification of the ability of safety functions to meet a safety requirement.
Category	Classification of the resistance to faults according to EN ISO 13849-1.
Safety integrity level claim limit (SIL CL)	SIL claim limit (suitability)
Probability of a dangerous failure per hour (PFH_d)	Probability of a dangerous failure per hour.
Mission time t_M	Duration of use
Probability of failure on demand (low demand) (PFD)	Probability of failure, relative to the number of demands.
DC	Diagnostic coverage
MTTF	Mean time to failure
AOPDDR	Active optoelectronic protective device responsive to diffuse reflection Device with a sensor function that is generated by optoelectronic transmit and receive elements, which detects the diffuse reflection of optical radiation generated in the device by an object located in a protective field specified in two dimensions.
AOPD	Active optoelectronic protective device Device with a sensor function that is generated by optoelectronic transmit and receive elements, which detects the interruption of optical radiation generated in the device by an opaque object located in the specified protective field (or for an optical data link on the axis of the light beam). In DIN EN 692 (mechanical presses), DIN EN 693 (hydraulic presses), and EN 12622 (hydraulic trimming presses), the abbreviation AOS is used as a synonym for AOPD.
SRCF	Safety-related control function - safety function
SRECS	Safety-related electric, electronic, programmable electronic control system

A 4 Index

A

Assumed effect2-1

C

Cable lengths3-2
 Example3-3
Category2-4, 2-5
Contact extension5-61
Cross-circuit detection3-1

D

Determination of the safety integrity level
according to EN 620612-10
Determination of the safety integrity level for
a subsystem with discrete components
according to EN 620612-10
Diagnostic description7-1
DIN rail plug-in connectors6-1

E

Emergency stop5-1
EN 620612-7
EN ISO 121002-1, 2-2
EN ISO 138492-2
Enable switch5-49

F

Forcibly guided contacts5-61
Functional safety2-2

G

Guard5-31

I

Interlocking device5-31

L

Laser scanner5-21
Light grid5-21

O

Overview of safe switching devices4-1

P

Performance level
 Determine2-3
 Determine for a subsystem2-4
 Determine for the overall safety function2-6
 Verification of the achieved PL2-6
PFH2-10

R

Risk graph2-3
Risk reduction2-2

S

Safe isolation3-6
Safety equipment5-31
Safety function
 Definition according to EN ISO 138492-2
 Dividing into subsystems2-4, 2-8
Safety integrity level (SIL)2-7
 Determine2-7
Safety lifecycle1-1
Safety service1-1
SRCF2-7
SRECS2-7
Stop category 03-4
Stop category 13-4
Stop category 23-5

T

TBUS6-1
Two-hand control devices5-57

